



GB	ENTRY PROTECTION FOIL Installation Instruction
D	EINSTIEGSLEISTENSCHUTZFOLIE Einbauanleitung
E	SIDE PELÍCULA DE PROTECCIÓN ALFÉIZAR Instrucciones de montaje
F	CÔTÉ FILM DE PROTECTION DE SEUIL Instructions de montage
I	SIDE PELLICOLA DI PROTEZIONE DAVANZALE Istruzioni di montaggio
P	PELÍCULA DE PROTEÇÃO SOLEIRA SIDE Instruções de montagem
NL	DORPELVERBREDERS BESCHERMFOLIE Inbouw-instructie
DK	VENTILATIONSGITTER BESKYTTELSE FILM Monteringsvejledning
N	VRIDERE FILM Monteringsveiledning

S	SIDO SILL SKYDDSFILM Monteringsanvisning
SF	SIVUHELMAVERHOUKSET SUOJAKALVO Asennusohje
CZ	BOČNÍ PRÁH OCHRANNÁ FÓLIE Návod k montáži
H	OLDALSÓ PÁRKÁNY FILM Beszerelési utasítás
PL	FOLIA OCHRONNA BOCZNA PARAPET Instrukcja zabudowy
GR	ΠΛΕΥΡΑ ΤΗΣ ΜΕΜΒΡΑΝΗΣ ΠΕΡΒΑΖΙ ΠΡΟΣΤΑΣΙΑ Οδηγίες τοποθέτησης
RUS	СТОРОНА ФИЛЬМ ПОДОКОННИК ЗАЩИТА инструкция по установке
SVK	VSTUPNÁ OCHRANNÁ FÓLIA Návod na inštaláciu

MAZDA 3 BP

[SDN]

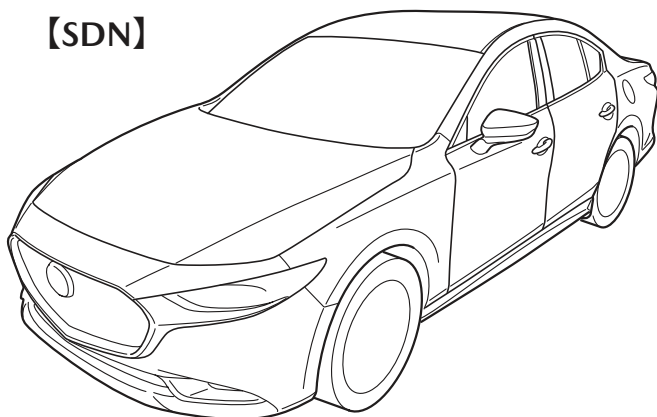

[5HB]

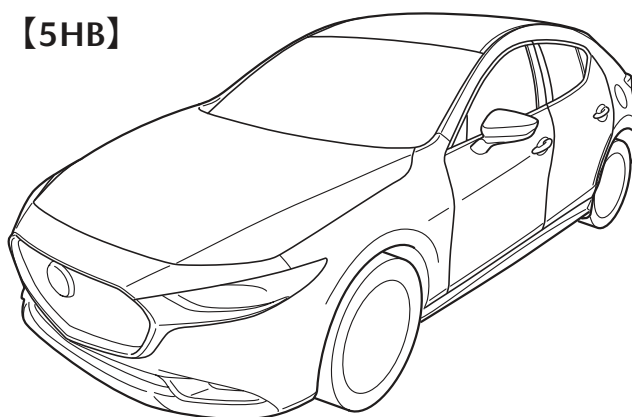

Part Number: BDEN-V1-360
BDEL-V1-360

MAZDA 3 (5HB)
MAZDA 3 (SDN)

Date: 15-02-2019

© Copyright MAZDA

Sheet 1 of 10

Expert Fitment Required
Montage durch Fachwerkstatt erforderlich
Montaje sólo por el concesionario
Montage par spécialiste nécessaire
E' necessario in officina specializzata
Especialista em montagem requerido
Montage door vakman nodig
Montage ved professionelt værksted påkrævet
Nødvendig med montering fra fagverksted
Verkstadsmontage erfordras
Asennus tarpeen merkkikorjaamossa
Montáž ve specializované dílně nutná
A szereléshez szakmúhely kell
Konieczny montaż przez warsztat specjalistyczny
Να τοποθεί απο συνεργείο
Необходима установка специалистами
Vyžaduje sa odborné vybavenie



- (GB)** Location/Position Arrow
- (D)** Positionspfeil
- (E)** Flecha de posición
- (F)** Flèche de Position
- (I)** Freccia di posizione
- (P)** Flexa de posição
- (NL)** Lokatie/Positie pijl
- (DK)** Lokaliseringspil
- (N)** Posisjonspil
- (S)** Positionpil
- (SF)** Paikannusnuoli
- (CZ)** Šipka na pozici
- (H)** Helyzetjelző nyíl
- (PL)** Strzałka położenia
- (GR)** Βέλος θέσης
- (RUS)** Позиция
- (SVK)** Šipka polohy

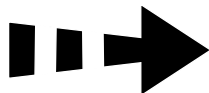

- (GB)** Movement Arrow
- (D)** Bewegungspfeil
- (E)** Flecha de movimiento
- (F)** Flèche indiquant sens du mouvement
- (I)** Freccia di movimentov
- (P)** Flexa de movimento
- (NL)** Richtingspijl
- (DK)** Bevægelsespil
- (N)** Bevegelsespil
- (S)** Rörelsepil
- (SF)** Liikesuuntanuoli
- (CZ)** Šipka pohybu
- (H)** Mozgásirányjelző nyíl
- (PL)** Strzałka kierunku ruchu
- (GR)** Βέλος κίνησης
- (RUS)** Стрелка по направлению
- (SVK)** Šipka pohybu



- (GB)** Look/See
- (D)** Siehe
- (E)** Ver
- (F)** Voir
- (I)** Vedere
- (P)** Cf.
- (NL)** Kijken naar
- (DK)** Se
- (N)** Se
- (S)** Se
- (F)** Katso
- (CZ)** Viz
- (H)** Lásd
- (PL)** Patrz
- (GR)** Βλέπω
- (RUS)** Смотрите
- (SVK)** Pozerať



- (GB)** Throw away
- (D)** Entsorgen
- (E)** Tratamiento de residuos
- (F)** Jeter aux déchets
- (I)** Smaltire
- (P)** Eliminar
- (NL)** Weggooien
- (DK)** Affald
- (N)** Avskaffe
- (S)** Ta hand om avfallet
- (SF)** Hävittää
- (CZ)** Vyhodit
- (H)** Távolítsa el
- (PL)** Usunąć jako odpad
- (GR)** Αποσύρση
- (RUS)** Выбросите
- (SVK)** Zahodit'



- (GB)** Warning
- (D)** Achtung
- (E)** Atención
- (F)** Attention
- (I)** Attenzione
- (P)** Atenção
- (NL)** Let op
- (DK)** Bemærk
- (N)** Pass på
- (S)** Varning
- (SF)** Huomio
- (CZ)** Pozor
- (H)** Figyelem
- (PL)** Uwaga
- (GR)** Προσοχή
- (RUS)** Осторожно
- (SVK)** Výstraha

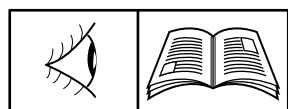

- (GB)** See Workshop Manual
- (D)** Siehe Werkstatthandbuch
- (E)** Ver manual de taller
- (F)** Voir Manuel d'atelier
- (I)** Vedere manuale officina
- (P)** Cf. o manual da oficina
- (NL)** Zie werkplaatshandboek
- (DK)** Se værkstedshåndbog
- (N)** Se verkstedshåndboka
- (S)** Se verkstadshandboken
- (F)** Katso korjaamon käsikirjasta
- (CZ)** Viz dílenskou příručku
- (H)** Lásd a Műhely-kézikönyvből
- (PL)** Patrz podręcznik warsztatowy
- (GR)** λάπε Εγχειρίδιο Συνεργείου
- (RUS)** Смотрите руководство для мастерской
- (SVK)** Pozrite si dielenskú príručku



- (GB)** Degrease
- (D)** Entfetten
- (E)** Desengrasar
- (F)** Dégraisser
- (I)** Sgrassare
- (P)** Desengordurar
- (NL)** Ontvetten
- (DK)** Fjerne fedt
- (N)** To bort fettet
- (S)** Avfetting
- (SF)** Rasvanpoisto
- (CZ)** Odmastit
- (H)** Zsírtalanítás
- (PL)** Odtłuszczyć
- (GR)** Απολίπανση
- (RUS)** Обезжирьте
- (SVK)** Odmastite

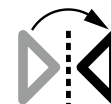

- (GB)** Mirror image
- (D)** Spiegelbild
- (E)** Imagen simétrica
- (F)** Image de miroir
- (I)** Immagine dello specchio
- (P)** Imagem do espelho
- (NL)** Mirror beeld
- (DK)** Spejlbilde
- (N)** Speilbilde
- (S)** Spegelbild
- (SF)** Peilikuva
- (CZ)** Věrný obraz
- (H)** Tükürcép
- (PL)** Odbicie lustrzane
- (GR)** εικ ανακθρεφτών
- (RUS)** Зеркальное отражение
- (SVK)** Zrkadlový obraz

MAZDA 3 BP

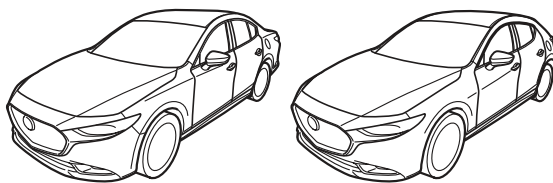

BDEN-V1-360 (5HB)
BDEL-V1-360 (SDN)

A



1x

B



1x

C



1x

D



1x

E

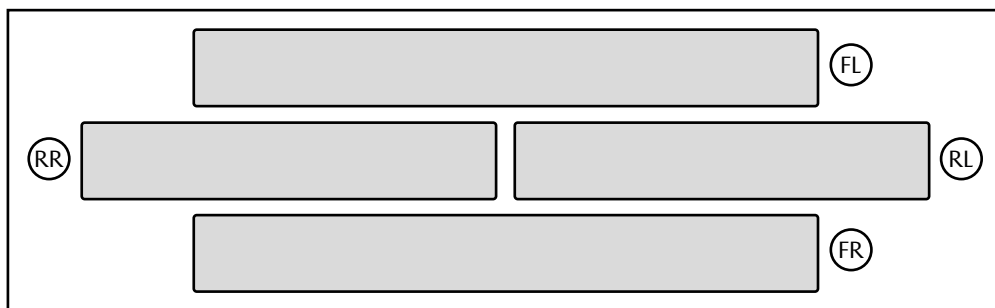

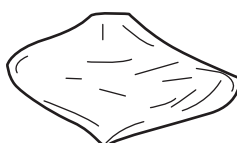
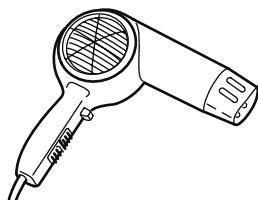

1x

Tools



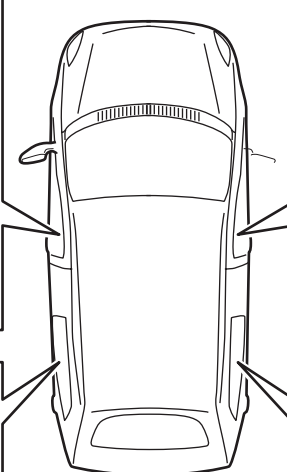

i
Info























FL





















RL





















FR















RR



Info

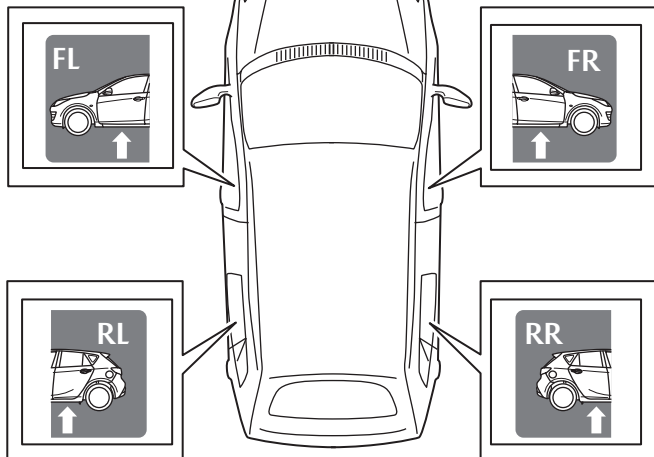

+ 30°C

+ 16°C

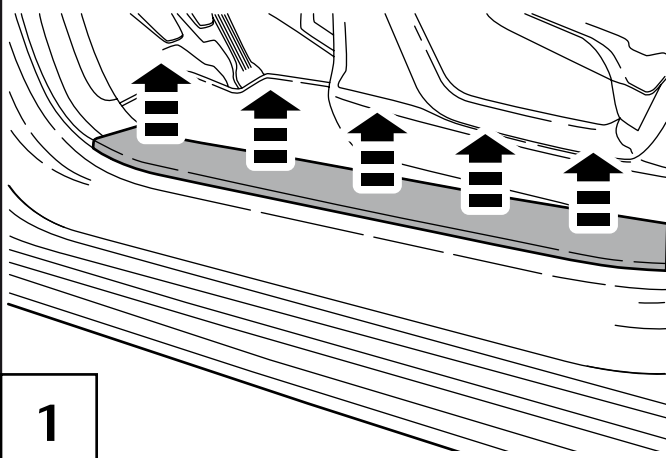
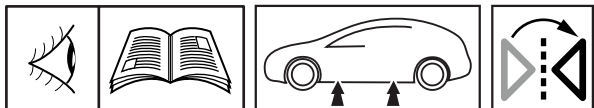
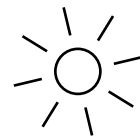

1

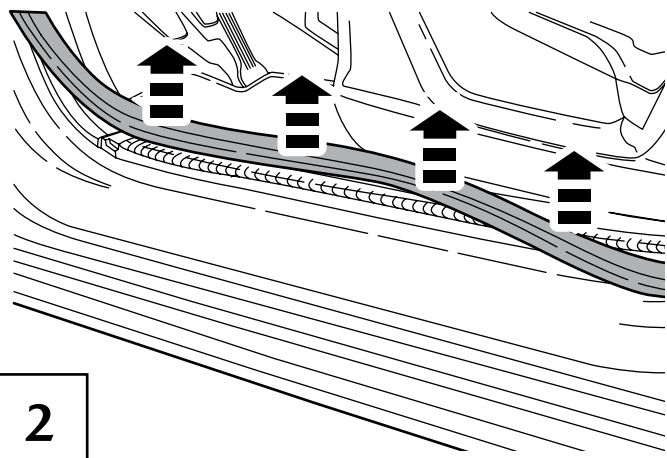
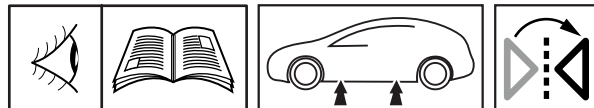

2

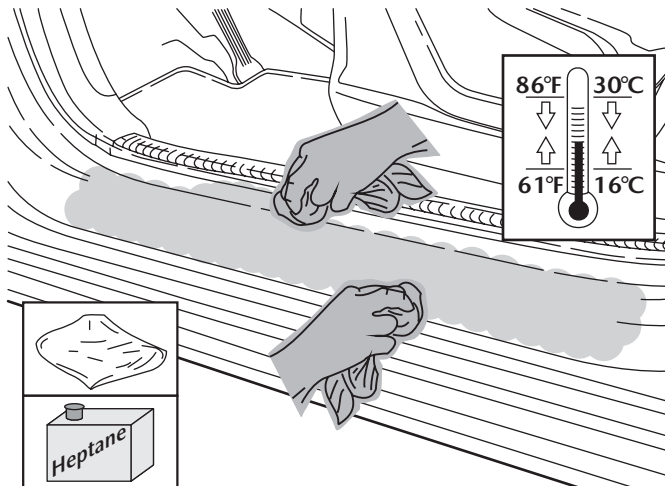
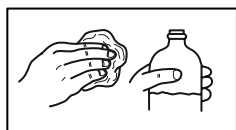
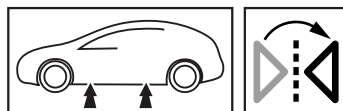

3

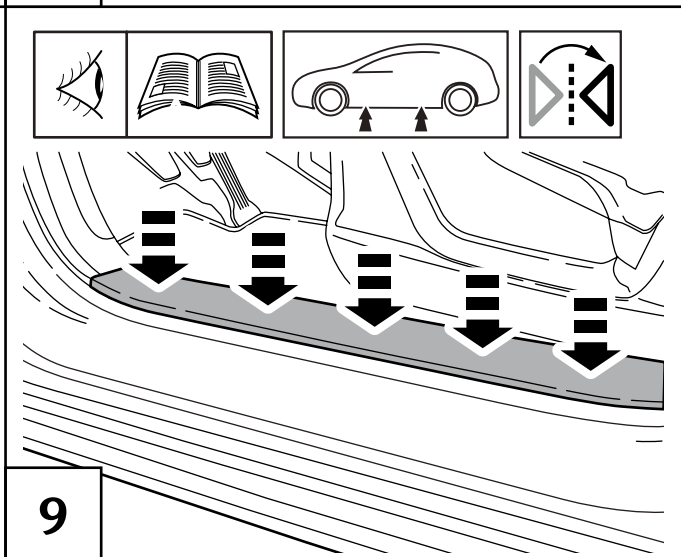
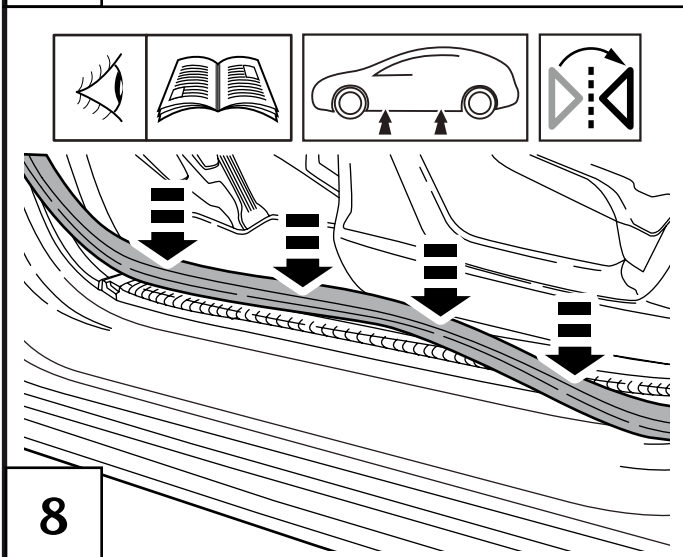
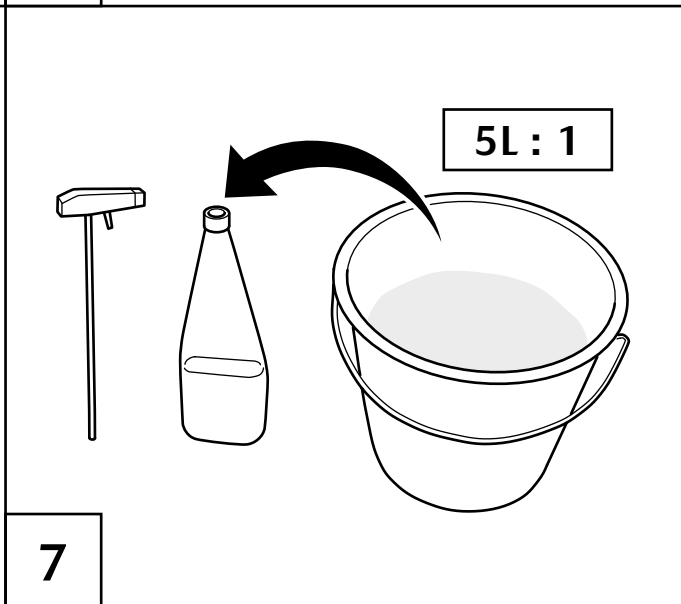
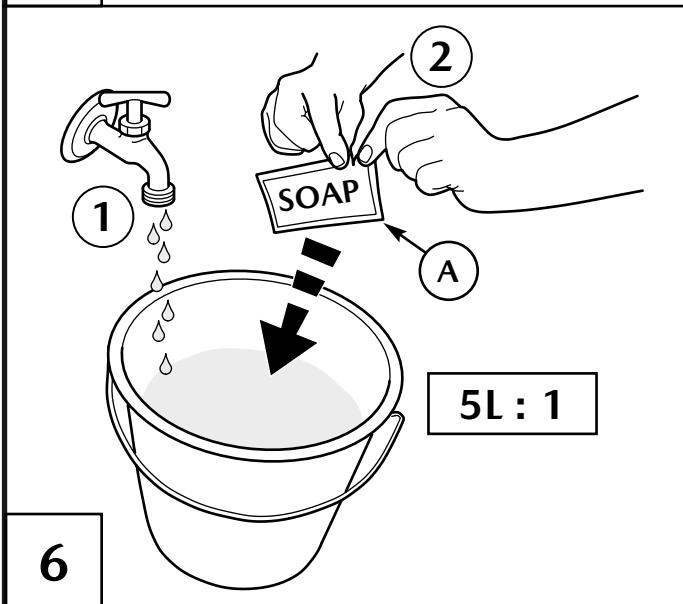
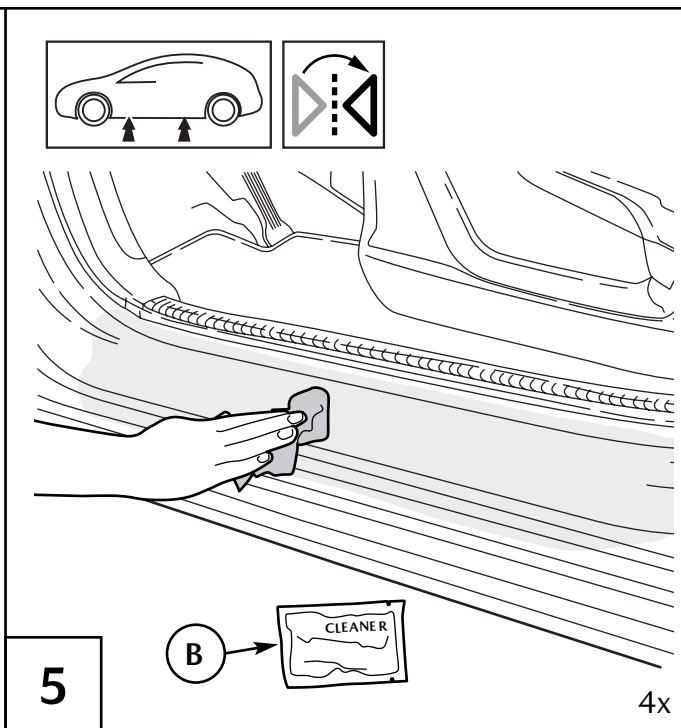
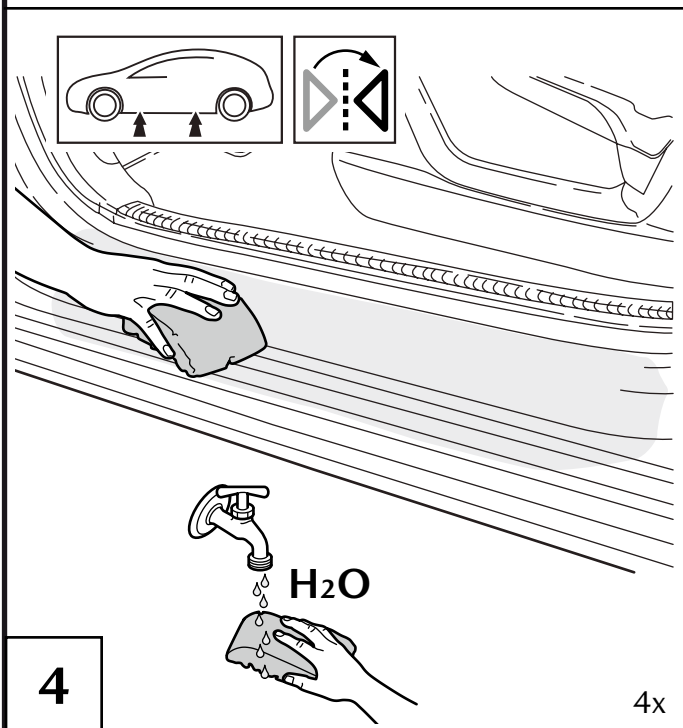

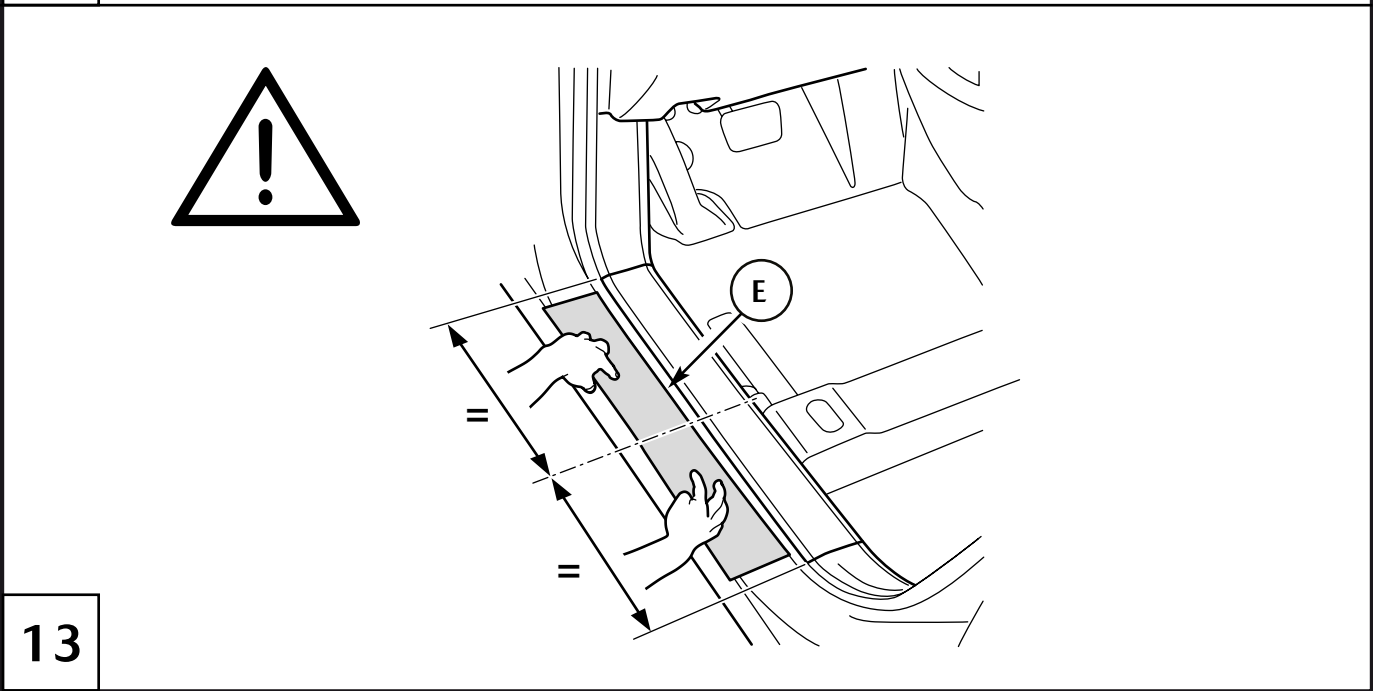
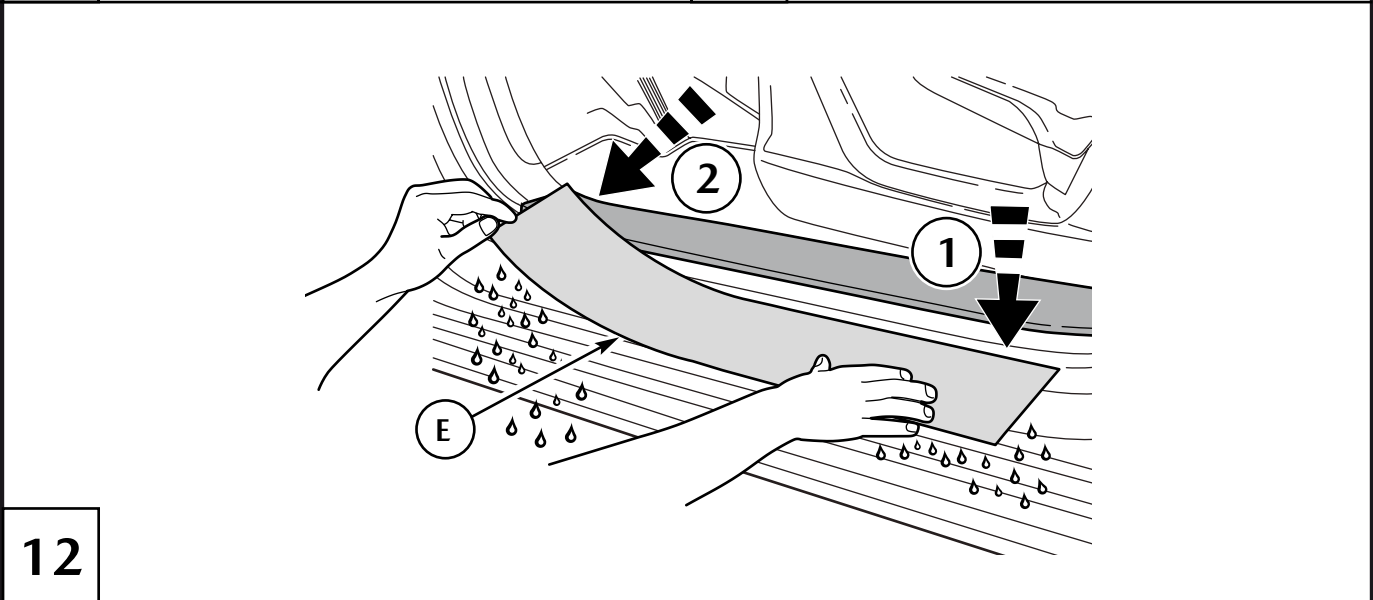
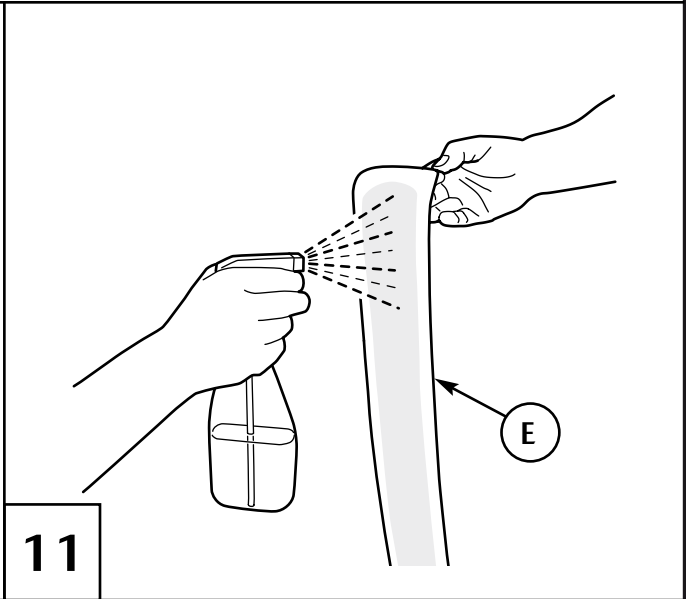
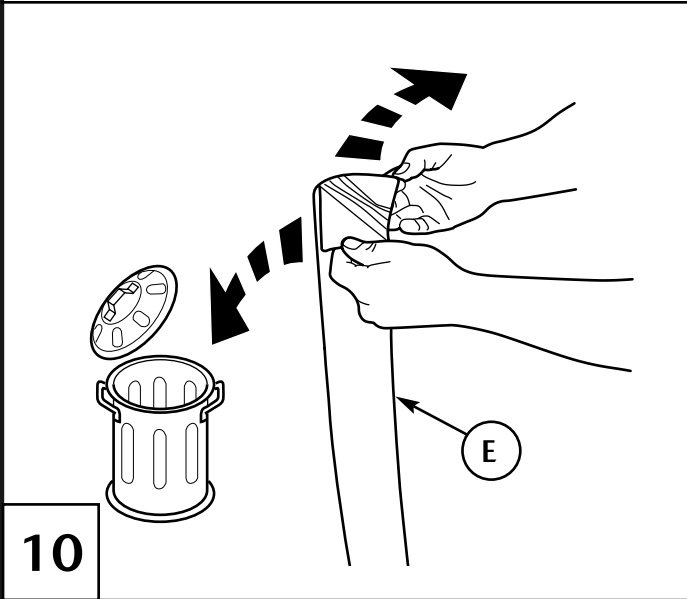

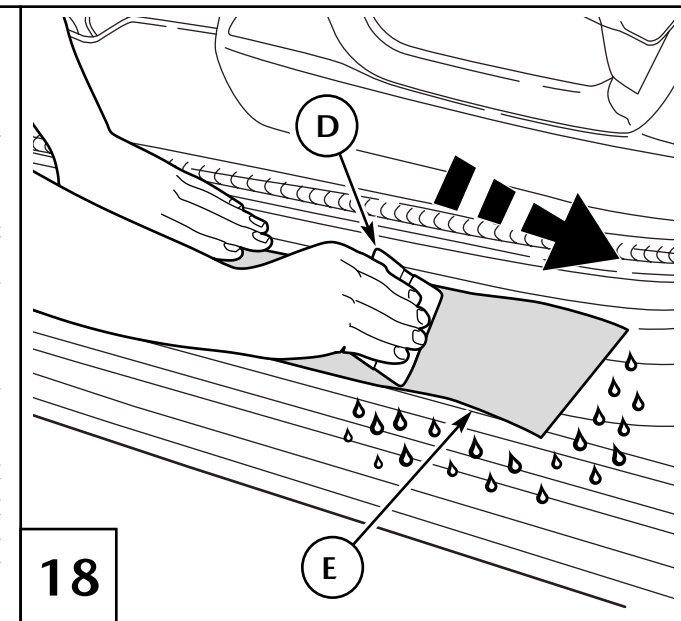
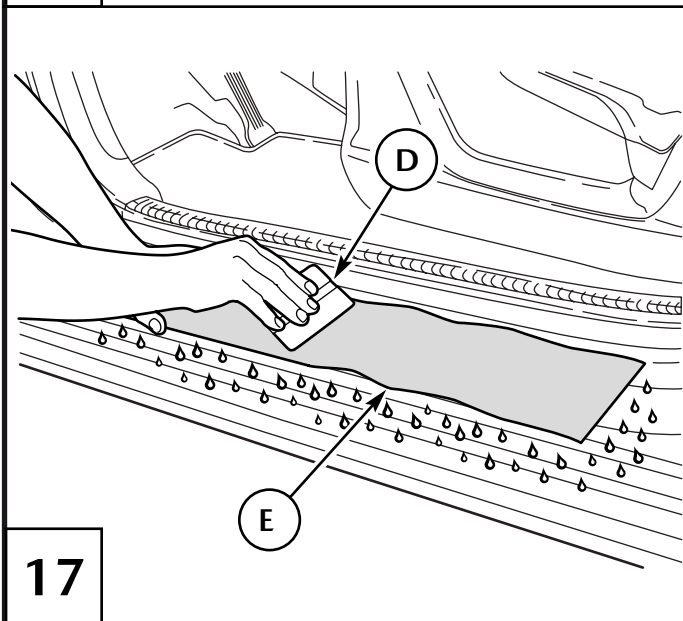
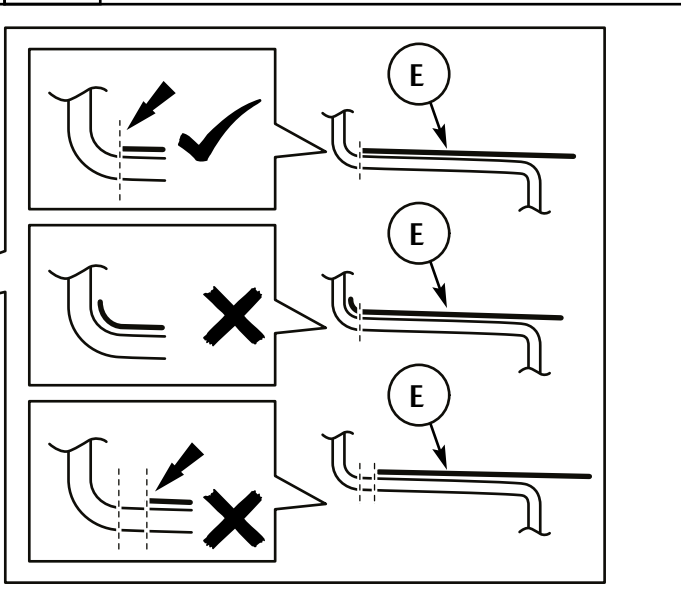
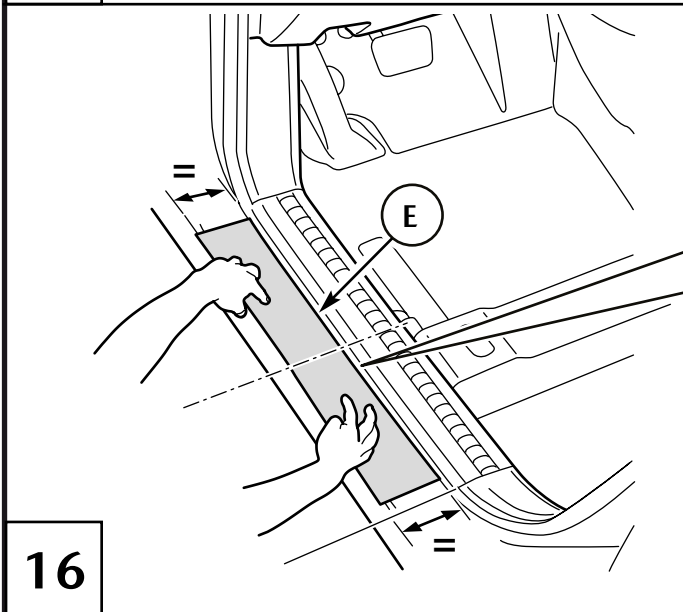
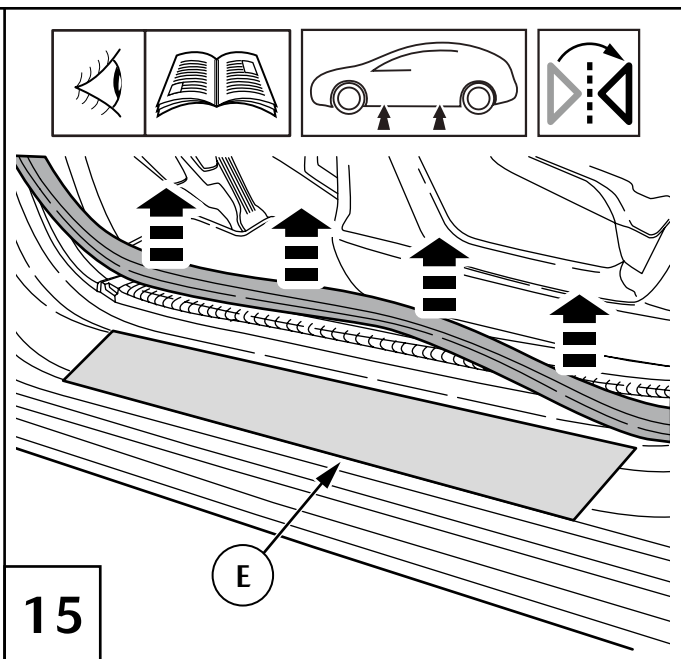
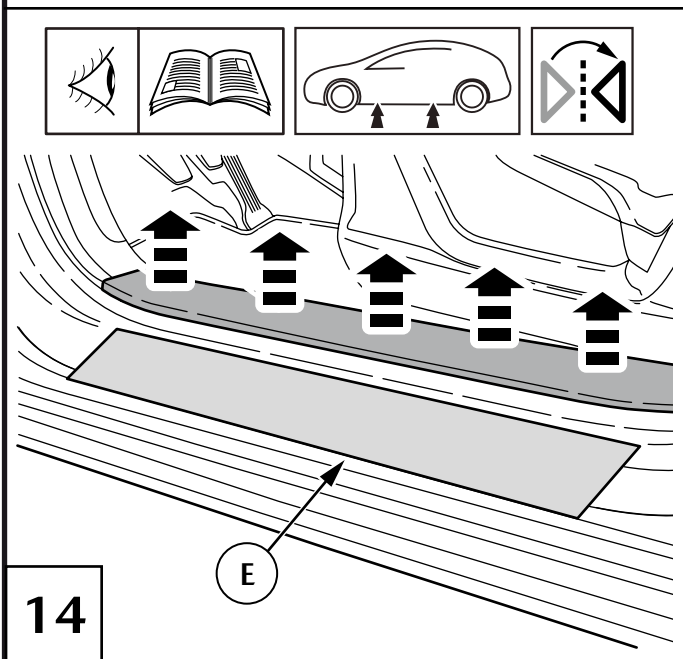

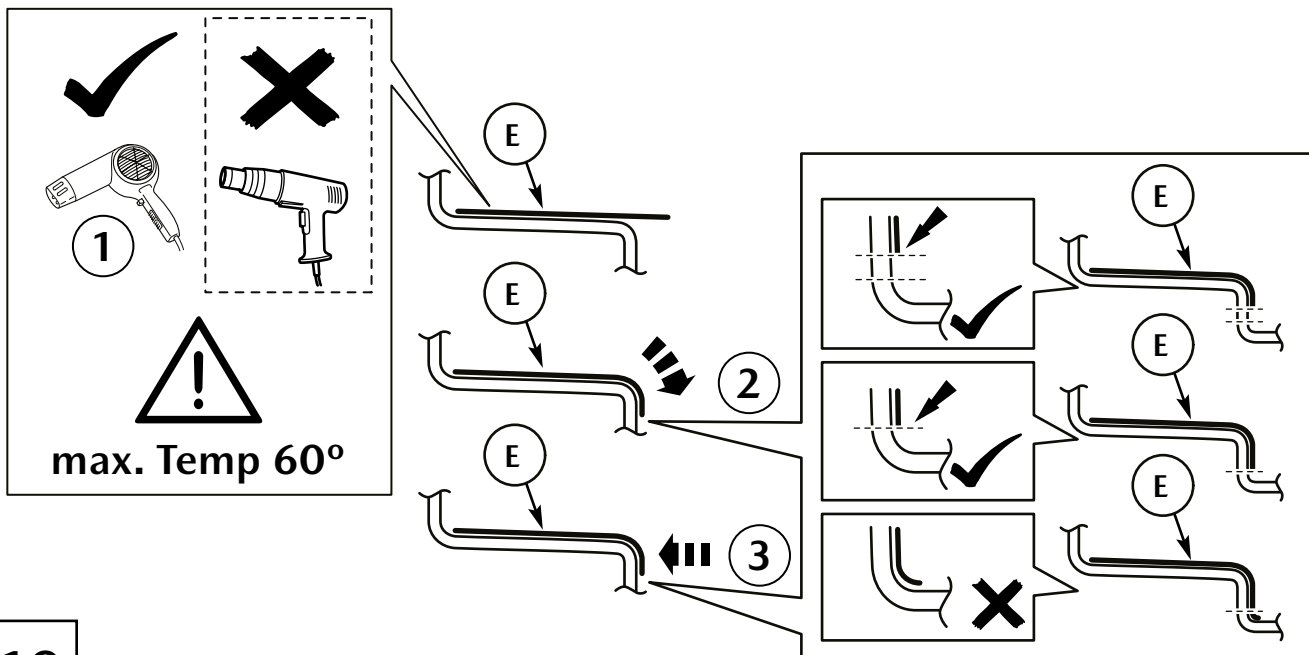

19

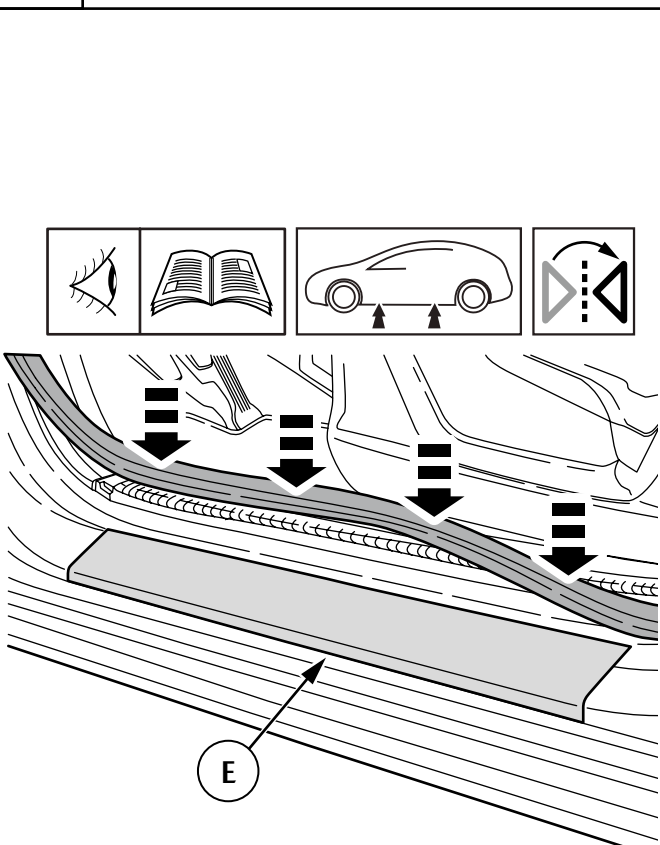

20

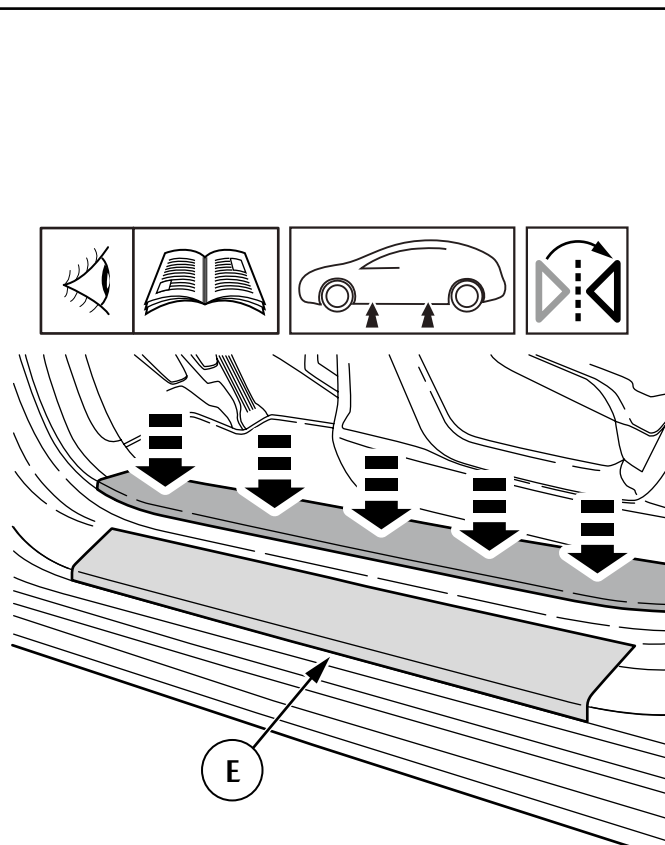

21

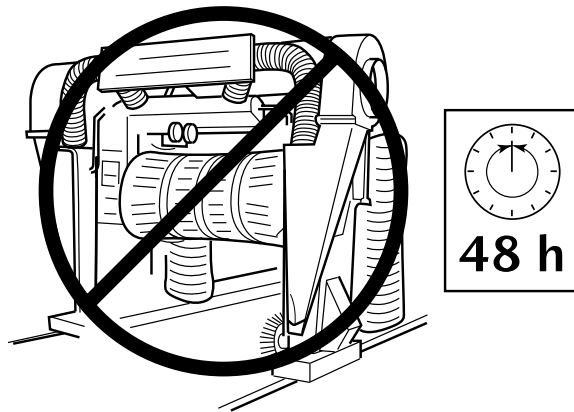
**22**

Subject to alternation without notice
Technische Änderungen vorbehalten
Reservadas modificaciones técnicas
Sous réserve de modifications techniques
Con riserva di apportare modifiche tecniche
Reservamo-nos o direito a alterações técnicas
Technische wijzigingen voorbehouden
Med forbehold for tekniske ændringer
Tekniske forendringer forbeholdes
Med reservation för tekniska ändringar
Tekniset muutokset pidätetään
Technické zmeny vyhrazeny
A változtatások technika jogát fenntartjuk
Zmiany techniczne zastrzeżone
Επιφύλασσόμεθα για αλλαγές
Можно изменять без уведомления
Technické zmeny vyhradené