

MAZDA

GB	PARKING AID (REAR) Installation Instruction
D	EINPARKHILFE (HINTEN) Einbauanleitung
E	CONTROL DE DISTANCIA PARA APARCAR (TRASERO) Instrucciones de montaje
F	ASSISTANCE DE RANGEMENT (ARRIÈRE) Instructions de montage
I	COLLIMATORE D'AUTO PARCHEGGIO (POSTERIORE) Istruzioni di montaggio
P	CONTROLE DE ESTACIONAMENTO À DISTÂNCIA (TRASEIRO) Instruções de montagem
NL	PARKEERHULP (ACHTER) Inbouw-instructie
DK	PARKEERHULP (BAGSIDE) Monteringsvejledning

N	PARKERINGSKONTROLL (BAK) Monteringsveiledning
S	PAERKINGSHJÄLP (BAK) Monteringsanvisning
SF	PYSÄKÖINTIAPU (TAKANA) Asennusohje
CZ	NAVÁDŮCÍ SYSTÉM PRO PARKOVÁNÍ (ZADNÍ) Návod k montáži
H	PARKOLÁSI TÁVOLSÁGJELZŐ (HÁTSÓ) Beszerelési utasítás
PL	PILOT PARKOWANIA (TYŁ) Instrukcja zabudowy
GR	Έλεγχος απόστασης παρκαρίσματος (πίσω) Οδηγίες τοποθέτησης
RUS	Парковочные сенсоры спереди сзади (сзади) инструкция по установке

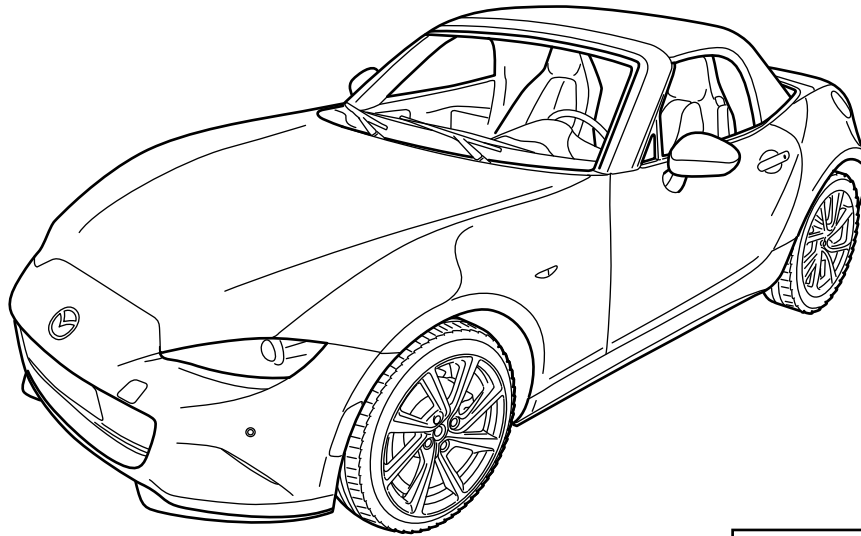

MX-5

ND

Part Number: C861-V7-285A

Date: 25-07-2017

© Copyright MAZDA

Sheet 1 of 20

Expert Fitment Required
Montage durch Fachwerkstatt erforderlich
Montaje sólo por el concesionario
Montage par spécialiste nécessaire
E' necessario in officina specializzata
Especialista em montagem requerido
Montage door vakman nodig
Montage ved professionelt værksted påkrævet
Nødvendig med montering fra fagvegværksted
Verkstadsmontage erfordras
Asennus tarpeen merkkikorjaamossa
Montáž ve specializované dílně nutná
A szereléshez szakműhely kell
Konieczny montaż przez warsztat specjalistyczny
Να τοποθεί απο συνεργείο
Необходима установка специалистами

Mazda Color Table

	GB	D	E	F	I	P	NL	DK
B	Black	Schwarz	Negro	Noir	Nero	Preto	Zwart	Sort
BE	Beige	Beige	Beige	Beige	Beige	Beige	Beige	Beige
BR	Brown	Braun	Marrón	Marron	Marrone	Castanho	Bruin	Brun
DG	Dark green	Dunkelgrün	Verde oscuro	Vert foncé	Verde scuro	Verde-escuro	Donkergroen	Mørkegrøn
DL	Dark blue	Dunkelblau	Azul oscuro	Bleu foncé	Blu scuro	Azul-escuro	Donkerblauw	Mørkeblå
G	Green	Grün	Verde	Vert	Verde	Verde	Greon	Grøn
GY	Grey	Grau	Gris	Gris	Grigio	Cinzeno	Grijs	Grå
L	Blue	Blau	Azul	Bleu	Blu	Azul	Blauw	Blå
LB	Light blue	Hellblau	Azul claro	Bleu clair	Blu chiaro	Azul-claro	Lichtblauw	Lyseblå
LG	Light green	Hellgrün	Verde claro	Vert clair	Verde chiaro	Verde-claro	Lichtgroen	Lysegrøn
N	Natural colour	Naturfarbe	Color natural	Nature	Colori naturali	Cores naturais	Naturel	Naturfarvet
O	Orange	Orange	Naranja	Orange	Arancione	Laranja	Oranje	Orange
P	Pink	Rosa	Rosa	Rose	Rosa	Rosa	Rosé	Rosa
PU	Purple	Purpur	Púrpura	Pourpre	Rosso porpora	Púrpura	Paars	Purpur
R	Red	Rot	Rojo	Rouge	Rosso	Vermelho	Rood	Rød
SB	Sky blue	Himmelblau	Azul cielo	Bleu ciel	Celeste	Azul-céu	Hemelsblauw	Himmelblå
T	Yellow brown	Gelbbraun	Amarillo-marrón	Marron-jaune	Giallomarrone	Castanho-amarelado	Geelbruin	Gulbrun
V	Violet	Violett	Violeta	Violet	Viola	Violeta	Violet	Violet
W	White	Weiß	Bianco	Blanc	Bianco	Branco	Wit	Hvid
Y	Yellow	Gelb	Amarillo	Jaune	Giallo	Amarelo	Geel	Gul

	N	S	SF	CZ	H	PL	GR	RUS
B	Sort	Svart	Musta	Černá	Fekete	Czarna	Μαύρο	Чёрный
BE	Beige	Beige	Beige	Beige	béžový	beżowy	Μπεζ	бежевый
BR	Brun	Brun	Ruskea	Hnědá	Barna	Brazowa	Καφέ	Коричневый
DG	Mørkegrønn	Mörkgrön	Tummanvihreä	Tmavozelená	Sötétzöld	Ciemnozielona	Σκούρο πράσινο	Тёмно-зелёный
DL	Mørkeblå	Mörkblå	Tummansininen	Tmavomodrá	Sötétkék	Granatowa	Σκούρο μπλε	Тёмно-синий
G	Grønn	Grön	Vihreä	Zelená	Zöld	Zielona	Πράσινο	Зелёный
GY	Grå	Grå	Harmaa	Šedá	Szürke	Szara	Γκρι	Серый
L	Blå	Blå	Sininen	Modrá	Kék	Niebieska	Μπλε	Синий
LB	Lyseblå	Ljusblå	Vaaleansininen	Bledémodrá	Világoskék	Jasnoniebieska	Ανοικτό μπλε	Голубой
LG	Lysegrønn	Ljusgrön	Vaaleanvihreä	Světlezelená	Világoszöld	Jasnozielona	Ανοικτό πράσινο	Светло-зелёный
N	Naturfarger	Naturfärger	Luonnonväri	Přírodní barva	Természetes színű	Barwy naturalne	Φυσικά χροκαλί	Телесный
O	Orange	Orange	Oranssi	Oranžová	Narancs	Pomarańczowa	Πορφυρό	Оранжевый
P	Rosa	Rosa	Rosa	Růžová	Rózsaszín	Różowa	Ροζ	Розовый
PU	Purpur	Pur Pur	PurPurra	Purpurová	Biborvörös	Purpurowa	Πορφυρό	Пурпурный
R	Rød	Röd	Punainen	Červená	Piros	Czerwona	Κόκκινο	Красный
SB	Himmelblå	Himmelsblå	Taivaansininen	Blankytá	Égszínkék	Bękitna	Γαλάζιο	Небесно-голубой
T	Gulbrun	Gulbrun	Keltaisenruskea	Žlutohnědá	Sárgásbarna	Żółtobrazowa	Κίτρινοκαφέ	Жёлто-коричневый
V	Fiolett	Violett	Violett	Fialová	Ibolyakék	Fioletowa	Μοβν	ФйФиолетовый
W	Hvid	Vit	Valkionen	Bílá	Fehér	Biała	Λευκό	Белый
Y	Gul	Gul	Keltainen	Žlutá	Sárga	Żółta	Κίτρινο	Жёлтый



- (GB)** Movement Arrow
- (D)** Bewegungspfeil
- (E)** Flecha de movimiento
- (F)** Flèche indiquant sens du vouvement
- (I)** Freccia di movimentov
- (P)** Flexa de movimento
- (NL)** Richtingspijl
- (DK)** Bevægelsespil
- (N)** Bevegelsespil
- (S)** Rörelsepil
- (SF)** Liikesuuntanuoli
- (CZ)** Šipka pohybu
- (H)** Mozgásirányjelző nyíl
- (PL)** Strzałka kierunku ruchu
- (GR)** Βέλος κίνησης
- (RUS)** Стрелка по направлению



- (GB)** See Workshop Manual
- (D)** Siehe Werkstatthandbuch
- (E)** Ver manual de taller
- (F)** Voir Manuel d'atelier
- (I)** Vedere manuale officina
- (P)** Cf. o manual da oficina
- (NL)** Zie werkplaatshandboek
- (DK)** Se værkstedshåndbog
- (N)** Se verkstedshåndboka
- (S)** Se verkstadshandboken
- (SF)** Katso korjaamon käsikirjasta
- (CZ)** Viz dílenskou příručku
- (H)** Lásd a Műhely-kézikönyvben
- (PL)** Patrz podręcznik warsztatowy
- (GR)** λέπε Εγχειρίδιο Συνεργείου
- (RUS)** Смотри руководство для мастерской



- (GB)** Refer to specific view
- (D)** Siehe Abbildung
- (E)** Ver figura
- (F)** Cf. figure
- (I)** Vedi figura
- (P)** Cf. figura
- (NL)** Zie tekeningnummer
- (DK)** Se fig.
- (N)** Se bilde
- (S)** Se figur
- (SF)** Katso kuva
- (CZ)** Viz obrázek
- (H)** Lásd az ábrán
- (PL)** Patrz rysunek
- (GR)** Βλέπε Εικ
- (RUS)** Смотри соответствующую картинку



- (GB)** Disconnect
- (D)** Abklemmen
- (E)** Desconectar
- (F)** Déconnecter
- (I)** Staccare
- (P)** Desligar
- (NL)** Demonteren
- (DK)** Frakobles
- (N)** Klem av
- (S)** Koppla los
- (SF)** Irrota
- (CZ)** Odpojit
- (H)** Szakítsa meg, kapcsolja szét
- (PL)** Rozłączyć
- (GR)** Αποσύνδεση
- (RUS)** Разъедините



- (GB)** Connect
- (D)** Verbinden
- (E)** Conectar
- (F)** Connecter
- (I)** Collegare
- (P)** Ligar
- (NL)** In elkaar
- (DK)** Kobles
- (N)** Tilkopling
- (S)** Ansult
- (SF)** Yhdistä
- (CZ)** Spojit
- (H)** Kapcsolja össze
- (PL)** Podłączyć
- (GR)** Σύνδεση
- (RUS)** Соедините



- (GB)** Warning
- (D)** Achtung
- (E)** Atención
- (F)** Attention
- (I)** Attenzione
- (P)** Atenção
- (NL)** Let op
- (DK)** Bemærk
- (N)** Pass på
- (S)** Varning
- (SF)** Huomio
- (CZ)** Pozor
- (H)** Figyelem
- (PL)** Uwaga
- (GR)** Προσχή
- (RUS)** Осторожно

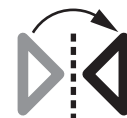

- (GB)** Mirror image
- (D)** Spiegelbild
- (E)** Imagen simétrica
- (F)** Image de miroir
- (I)** Immagine dello specchio
- (P)** Imagem do espelho
- (NL)** Mirror beeld
- (DK)** Spejlbillde
- (N)** Speilbilde
- (S)** Spiegelbild
- (SF)** Peilikuva
- (CZ)** Věrný obraz
- (H)** Tükürcép
- (PL)** Odbicie lustrzane
- (GR)** εικ ανακρεφτών
- (RUS)** Зеркальное отражение



- (GB)** Throw away
- (D)** Entsorgen
- (E)** Tratamiento de residuos
- (F)** Jeter aux déchets
- (I)** Smaltire
- (P)** Eliminar
- (NL)** Weggoaien
- (DK)** Affald
- (N)** Avskaffe
- (S)** Ta hand om avfallet
- (SF)** Hävittää
- (CZ)** Vyhodit
- (H)** Távolítsa el
- (PL)** Usunąć jako odpad
- (GR)** Απόσυρση
- (RUS)** Выбросите

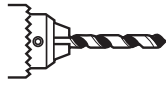

- (GB)** Use Drill
- (D)** Bohrer verwenden
- (E)** Utilizar broca
- (F)** Utiliser une mèche
- (I)** Utilizzare trapano
- (P)** Utilizar a perfuradora
- (NL)** Boordiameter
- (DK)** Bor anvendes
- (N)** Bruk diameter
- (S)** Använd borr
- (SF)** Käytä poraa
- (CZ)** Použít vrták
- (H)** Használjon fúrót
- (PL)** Stosować wiertarkę
- (GR)** Χρησιμοποιείτε τρυπάνι
- (RUS)** Используйте дрель

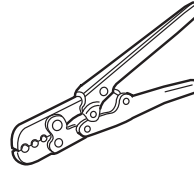

- (GB)** Use Crimping Tool
- (D)** Kabelschuhzange verwenden
- (E)** Utilizar alicates para terminales de cables
- (F)** Use pince pour broches de câble
- (I)** Utilizzare pinza per capocorda
- (P)** Sujeitar com fita adesiva
- (NL)** Kabelschoentang
- (DK)** Kabelskotang anvendes
- (N)** Bruk kabelskotang
- (S)** Använd kabelskotång
- (SF)** Käytä kaapelikenkäpihtejä
- (CZ)** Použít kleště na kabelová oka
- (H)** Használjon kábelsarufogót
- (PL)** Stosować cęgi do końcówek kablowych
- (GR)** Χρησιμοποιείτε πένσα πέδιλων αλωδίων
- (RUS)** Используйте щипцы с кабельным наконечником



- (GB)** Location/Position Arrow
- (D)** Positionspfeil
- (E)** Flecha de posición
- (F)** Flèche de Position
- (I)** Freccia di posizione
- (P)** Flexa de posição
- (NL)** Lokatie/Positie pijl
- (DK)** Lokaliseringspil
- (N)** Posisjonspil
- (S)** Positionpil
- (SF)** Paikannusnuoli
- (CZ)** Šipka na pozici
- (H)** Helyzetjelző nyíl
- (PL)** Strzałka położenia
- (GR)** Βέλος θέσης
- (RUS)** Позиция



- (GB)** Tape up
- (D)** Mit Klebeband befestigen
- (E)** Fijar con cinta adhesiva
- (F)** Fixer avec ruban adhésif
- (I)** Fissare con nastro adesivo
- (P)** Sujeitar com fita adesiva
- (NL)** Vastzetten met tape
- (DK)** Fastgøres med tape
- (N)** Fest fast med klebeband
- (S)** Fästed med tejp
- (SF)** Kiinnitys teipillä
- (CZ)** Upevnit lepicí páskou
- (H)** Rögzítse ragasztószalaggal
- (PL)** Umocować taśmą samoprzylepną
- (GR)** Στερέωση με κολλητική ταινία
- (RUS)** Прикрепите клейкой лентой



- (GB)** Tighten
- (D)** Festdrehen
- (E)** Apretar fuerte girando
- (F)** Bien serrer
- (I)** Stringere bene
- (P)** Apertar bem
- (NL)** Vastdraaien
- (DK)** Tilspændes
- (N)** Drei fast
- (S)** Dra fast
- (SF)** Kiristä tiukalle
- (CZ)** Utáhnout
- (H)** Feszesen csavarja be
- (PL)** Silnie dokręcić
- (GR)** Περιοτροφή γερά
- (RUS)** Закрутите



- (GB)** Use Scissors
- (D)** Schere verwenden
- (E)** Utilizar tijeras
- (F)** Utiliser des ciseaux
- (I)** Utilizzare forbice
- (P)** Utilizar serra
- (NL)** Gebruik Schaar
- (DK)** Saks anvendes
- (N)** Bruk saks
- (S)** Använd sax
- (SF)** Käytä saksia
- (CZ)** Použít nůžky
- (H)** Használjon ollót
- (PL)** Stosować nożyce
- (GR)** Χρησιμοποιείτε αλίδ
- (RUS)** Использовать ножницы



- (GB)** Make Wire Tool
- (D)** Metalldraht verwenden
- (E)** Utilizar alambre metálico
- (F)** Utiliser un fil métallique
- (I)** Utilizzare filo metallico
- (P)** Utilizar fio de metal
- (NL)** Gebruik metaaldraad
- (DK)** Metaltråd anvendes
- (N)** Bruk metalltråd
- (S)** Använd metalltråd
- (SF)** Käytä metallilankaa
- (CZ)** Použít kovový drát
- (H)** Használjon fémdrót
- (PL)** Stosować drut metalowy
- (GR)** Χρησιμοποιείτε μεταλλικό σύρμα
- (RUS)** Использовать металлическую проволоку



- (GB)** Pierce with Sharp Implement
- (D)** Dorn verwenden
- (E)** Utilizar punzón
- (F)** Utiliser un mandrin
- (I)** Utilizzare mondrilo
- (P)** Utilizar mandril
- (NL)** Priem
- (DK)** Syl anvendes
- (N)** Bruk syl
- (S)** Använd dorn
- (SF)** Käytä tuurnaa
- (CZ)** Použití trn
- (H)** Használjon tűskét
- (PL)** Stosować przebijak
- (GR)** Χρησιμοποιείτε στυγέα
- (RUS)** Использовать пробойник



- (GB)** Cut with Craft Knife
- (D)** Mit Messer ausschneiden
- (E)** Recortar con cuchillo
- (F)** Découper avec couteau
- (I)** Ritagliare con coltello
- (P)** Cortar
- (NL)** Wegsnijden
- (DK)** Udskæres med kniv
- (N)** Skjær ut med kniv
- (S)** Skär ut med kniv
- (SF)** Leikkaa irti veitsellä
- (CZ)** Vyříznout nožem
- (H)** Vágja ki késsel
- (PL)** Wyciąć nożem
- (GR)** Κοπή με μαχαίρι
- (RUS)** Вырезать ножом

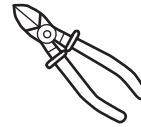

- (GB)** Use Wire Cutters
- (D)** Zange verwenden
- (E)** Utilizar alicates
- (F)** Utiliser pince
- (I)** Utilizzare pinza
- (P)** Utilizar pinca
- (NL)** Doorknippen
- (DK)** Tang anvendes
- (N)** Bruk tang
- (S)** Använd tång
- (SF)** Käytä pihtejä
- (CZ)** Použití kleště
- (H)** Használjon fogót
- (PL)** Stosować obcęgi
- (GR)** Χρησιμοποιείτε πέυσα
- (RUS)** Использовать клещи



- (GB)** Degrease
- (D)** Entfetten
- (E)** Desengrasar
- (F)** Dégraisser
- (I)** Sgrassare
- (P)** Desengordurar
- (NL)** Ontvetten
- (DK)** Fjerne fedt
- (N)** To bort fettet
- (S)** Avfettning
- (SF)** Rasvanpoisto
- (CZ)** Odmastit
- (H)** Zsírtalanítás
- (PL)** Odtłuszczyć
- (GR)** Απολίπανση
- (RUS)** Обезжирить



- (GB)** Correct
- (D)** Richtig
- (E)** Correcto
- (F)** Correct
- (I)** Giusto
- (P)** Certo
- (NL)** Goed
- (DK)** Rigtig
- (N)** Riktig
- (S)** Rätt
- (SF)** Oikein
- (CZ)** Správně
- (H)** Helyes
- (PL)** Prawidłowo
- (GR)** Σωστό
- (RUS)** Правильно



- (GB)** Incorrect
- (D)** Falsch
- (E)** Erróneo
- (F)** Incorrect
- (I)** Sbagliato
- (P)** Errado
- (NL)** Fout
- (DK)** Forkert
- (N)** Feilt
- (S)** Fel
- (SF)** Väärin
- (CZ)** Špatně
- (H)** Helyes
- (PL)** Nieprawidłowo
- (GR)** Λάθος
- (RUS)** Неправильно



- (GB)** Mark with Pencil
- (D)** Mit Bleistift anzeichnen
- (E)** Marcar con lápiz
- (F)** Marquer avec crayon
- (I)** Segnare con matita
- (P)** Marcar con lápiz
- (NL)** Aftekenen
- (DK)** Notér med blyant
- (N)** Påtegne
- (S)** Rita upp med blyertspenna
- (SF)** Merkitse lyijykynällä
- (CZ)** Naznačit tužkou
- (H)** Rajzolja be ceruzával
- (PL)** Zaznaczyć ołówkiem
- (GR)** Σημαδεμα/Σχεδιασμός με μολύβι
- (RUS)** Отметить карандашом





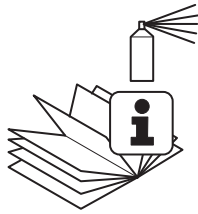



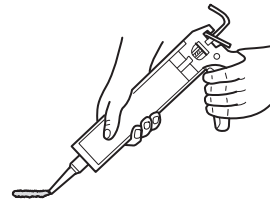

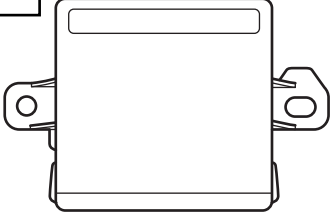
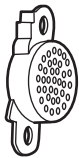
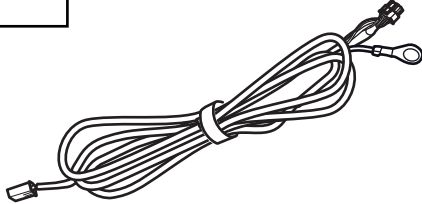

- (GB)** Use File
- (D)** Feile verwenden
- (E)** Utilizar lima
- (F)** Utiliser lime
- (I)** Utilizzare lima
- (P)** Utilizar lima
- (NL)** Vijl
- (DK)** Fil anvendes
- (N)** Bruk fil
- (S)** Använd fil
- (SF)** Käytä viilaa
- (CZ)** Použití pilník
- (H)** Használjon reszelőt
- (PL)** Stosować pilnik
- (GR)** Χρησιμοποιείτε λίμα
- (RUS)** Использовать напильник

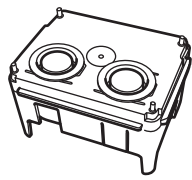
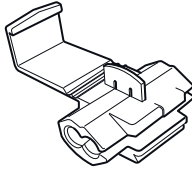

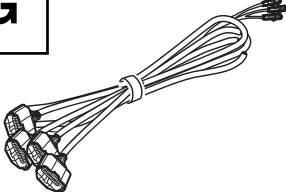
- (GB) See Bodyshop Manual
- (D) Siehe Karosserie-Werkstatthandbuch
- (E) Leer el manual del taller de carrocería
- (F) Voir manuel d'atelier pour la carrosserie
- (I) Consultare il Manuale di Carrozzeria
- (P) Vide Manual de Carroçaria
- (NL) Zie Handboek carrosserieherstelling
- (DK) Se karosseriværkstedshåndbog
- (N) Se karosseriværkstedshåndboka
- (S) Se karosseriværkstadshandboken
- (SF) Katso peltikorjaamon käsikirjasta
- (CZ) Více informací v servisním manuálu
- (H) Lásd a karosszéria-javítási kézikönyvből
- (PL) Zobacz Podręcznik Napraw Nadwozia
- (GR) δείτε το εγχειρίδιο του αμαξώματος
- (RUS) Смотрите Инструкцию по эксплуатации

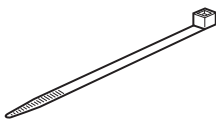
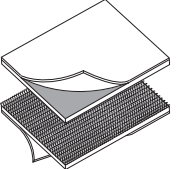
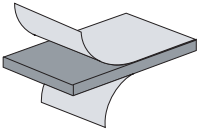
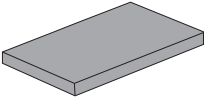

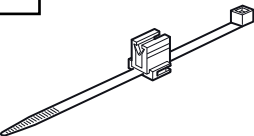
- (GB) Use Mastic Sealer Gun
- (D) Kartuschenpistole verwenden
- (E) Utilizar pistola de cartuchos
- (F) Utiliser pistolet à cartouche
- (I) Utilizzare pistola a cartuccia
- (P) Utilizar pistola de cartucho
- (NL) Kitspuit
- (DK) Fugemassepistol anvendes
- (N) Bruk kartusjipistol
- (S) Använd patronpistol
- (SF) Käytä karussipistoolia
- (CZ) Použít kartušovou pistoli
- (H) Használjon hüvellyel tölthető pisztolyt
- (PL) Stosować pistolet karuszowy
- (GR) Χρησιμοποιείτε πιστολέτο φυσιγγίων
Kartuş tabancası kullanınız
- (RUS) Использовать картушный пистолет

A  1x	B  1x	C  1x	
D  4x C860-V7-281 =  2x	E  1x	F  3x	
G  C860-V7-289 1x	H  4x	I  30x	J  1x
K  1x	L  1x	M  4x =  2x	
N  4x	O  1x	P  1x	

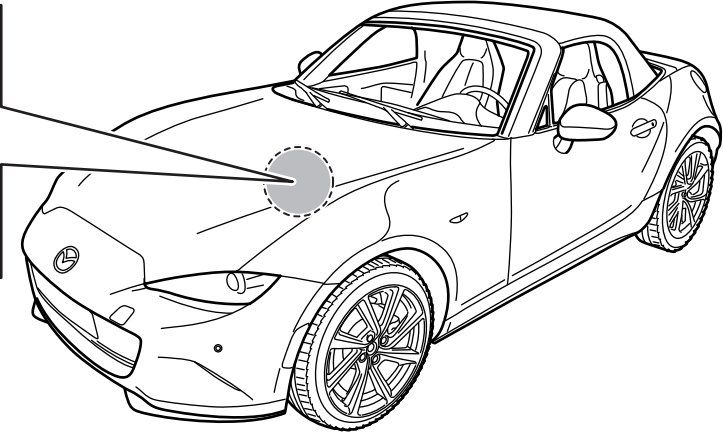
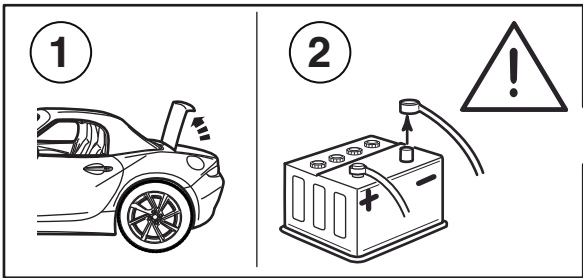

1

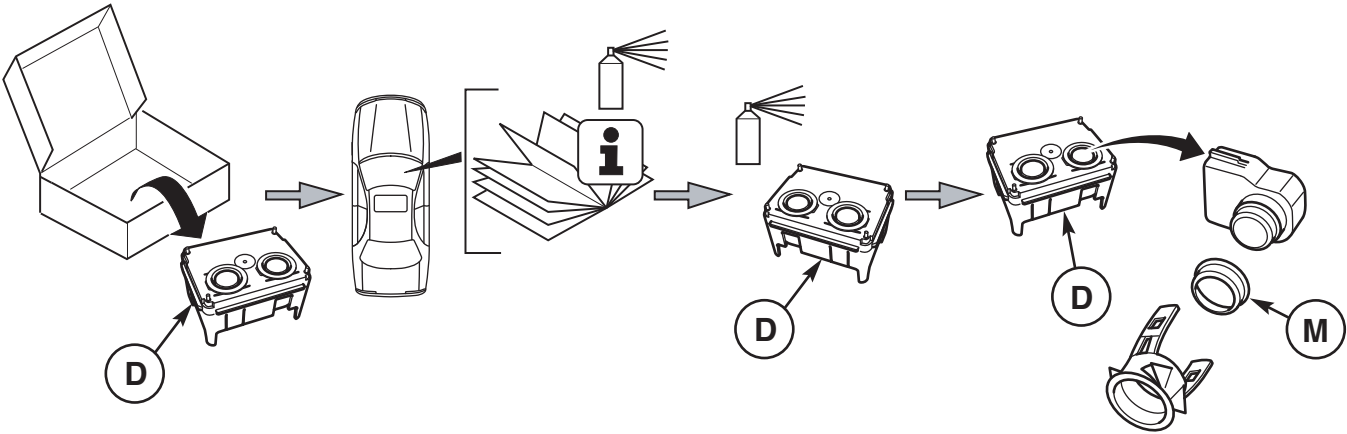

2

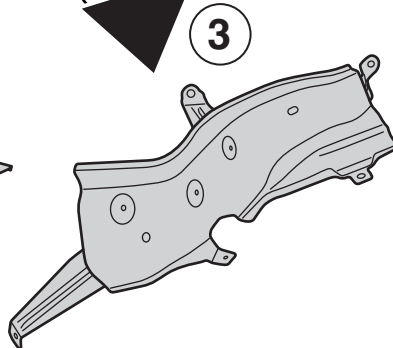
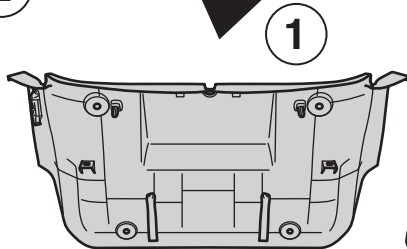
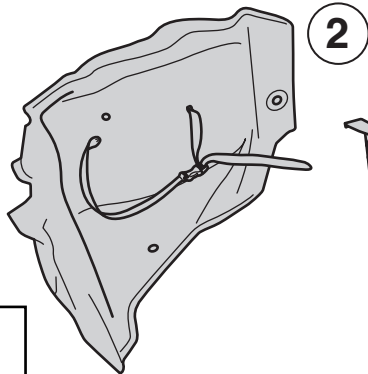
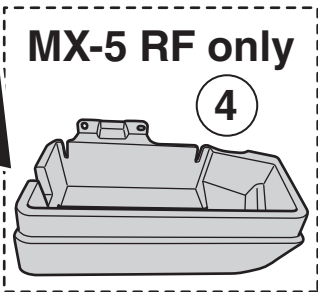
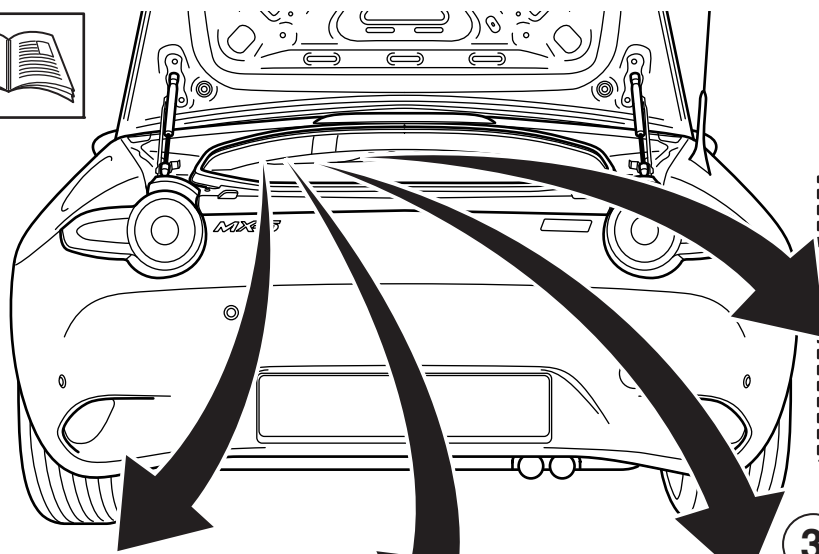

3

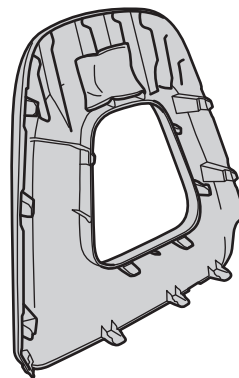
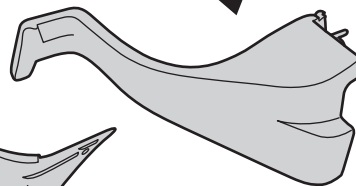
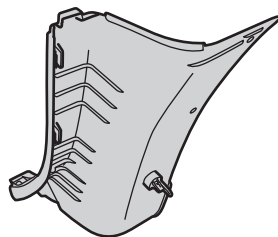
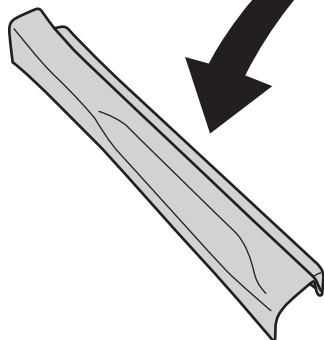
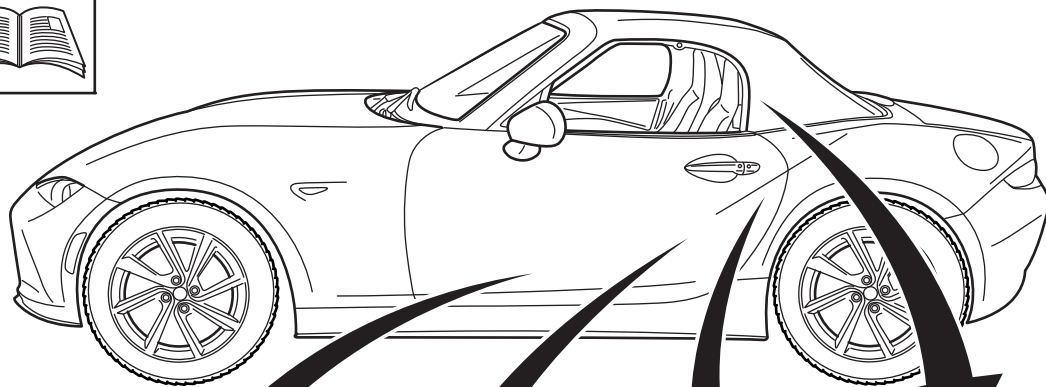

4

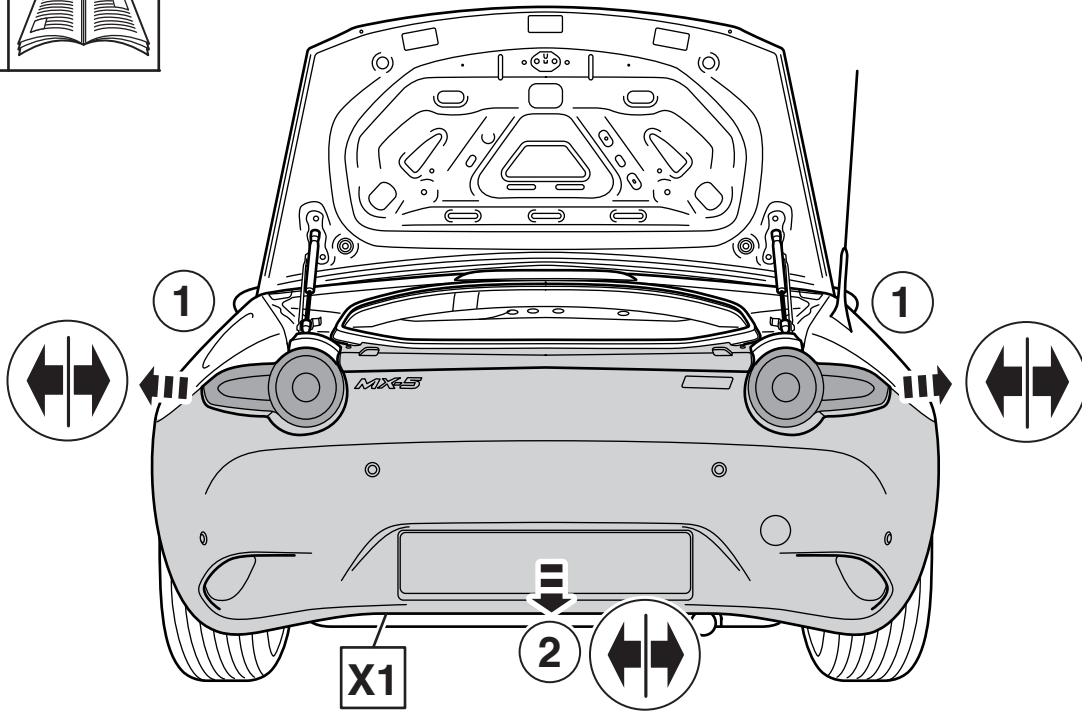

5

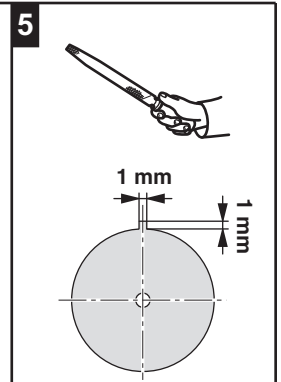
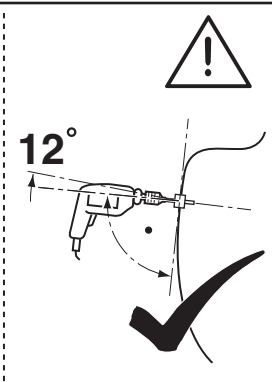
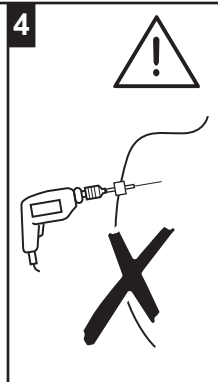
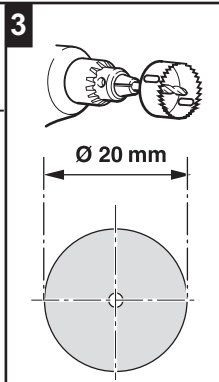
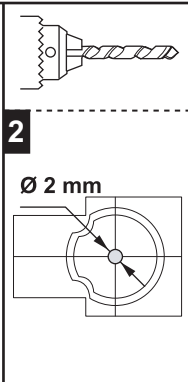
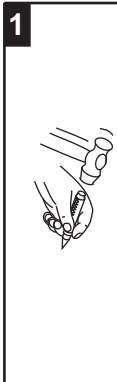
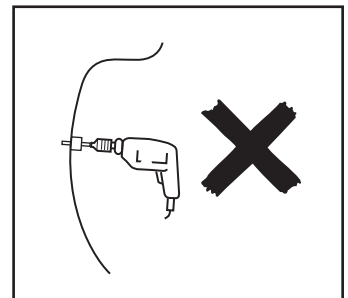
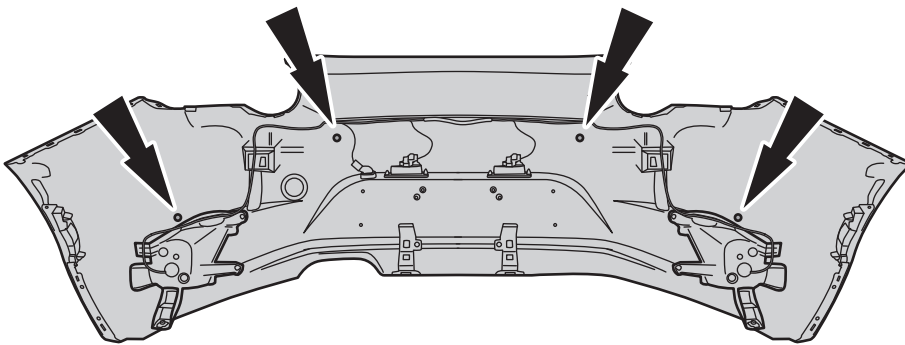

6

with RVM

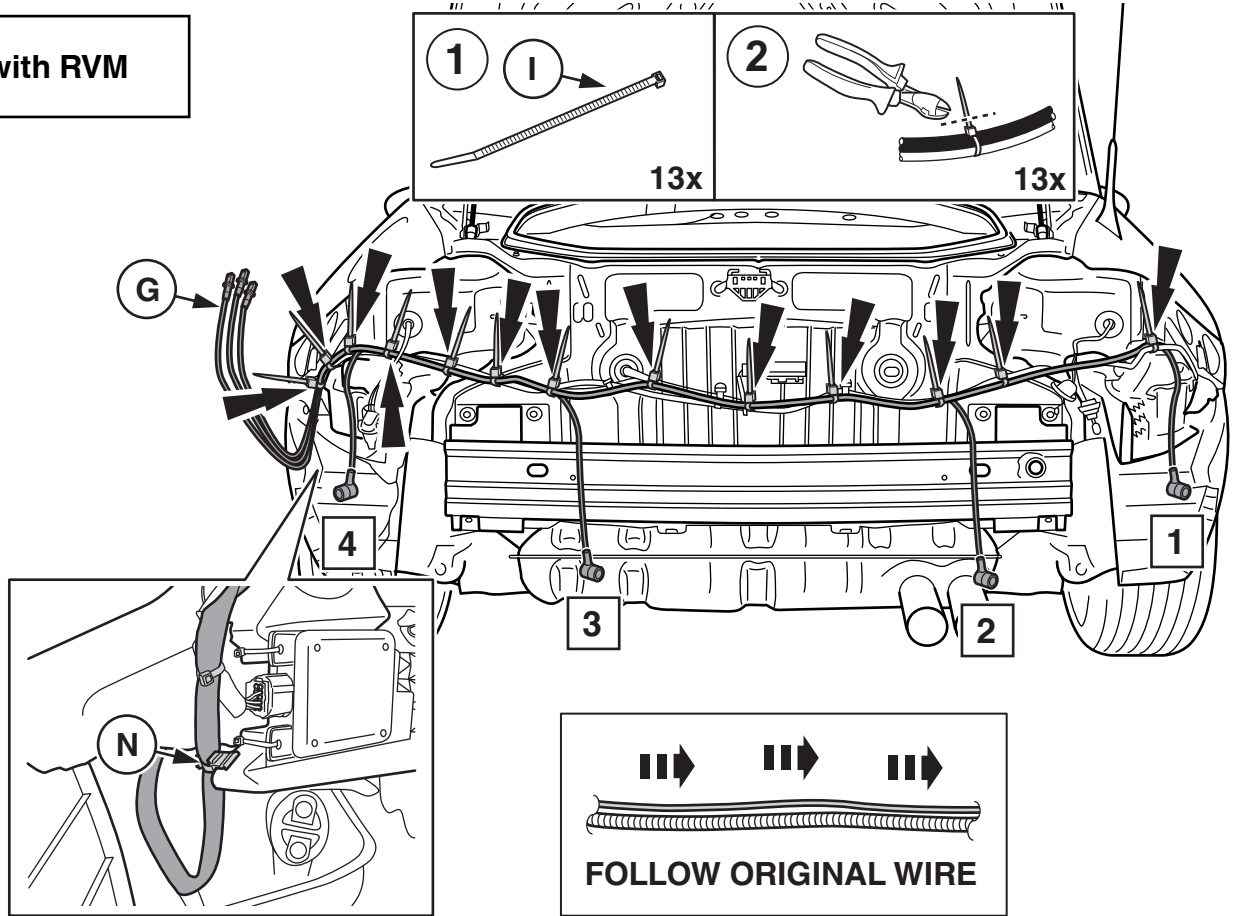

without RVM

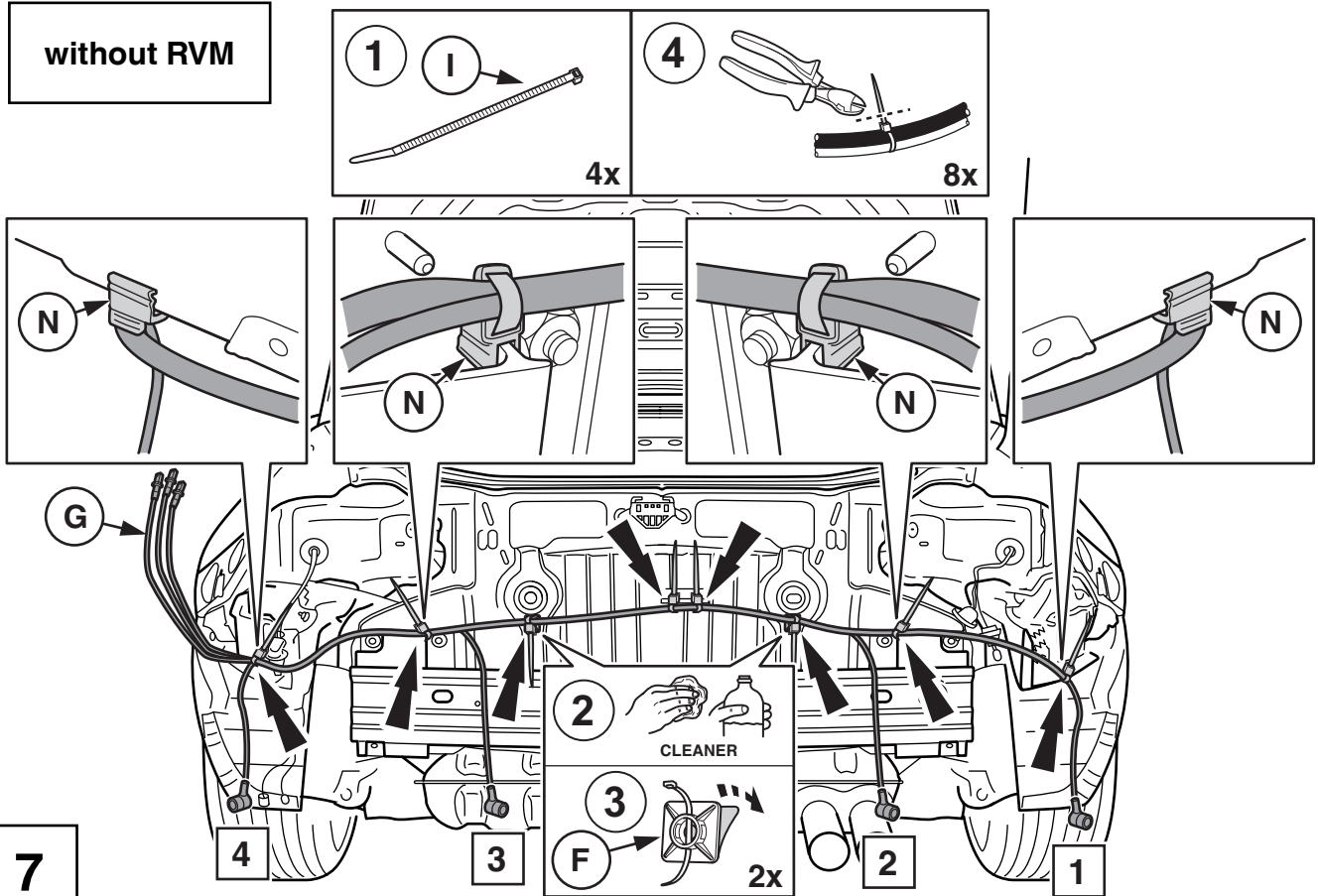

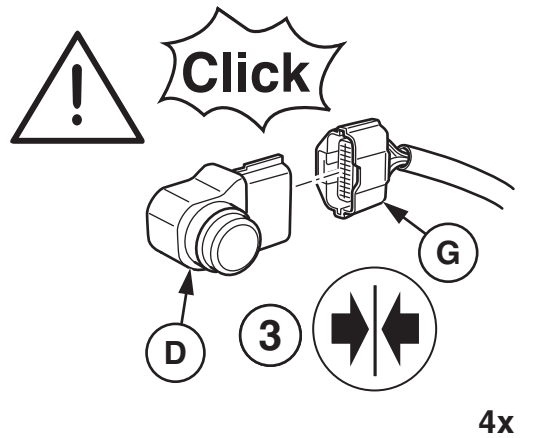
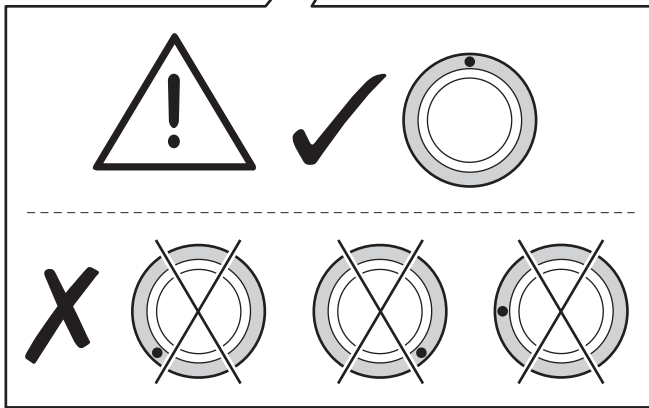
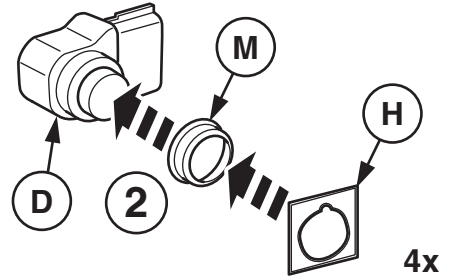
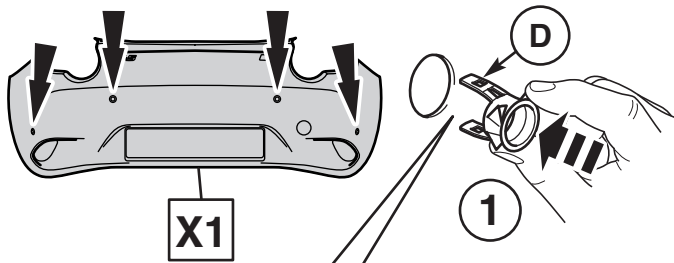

8

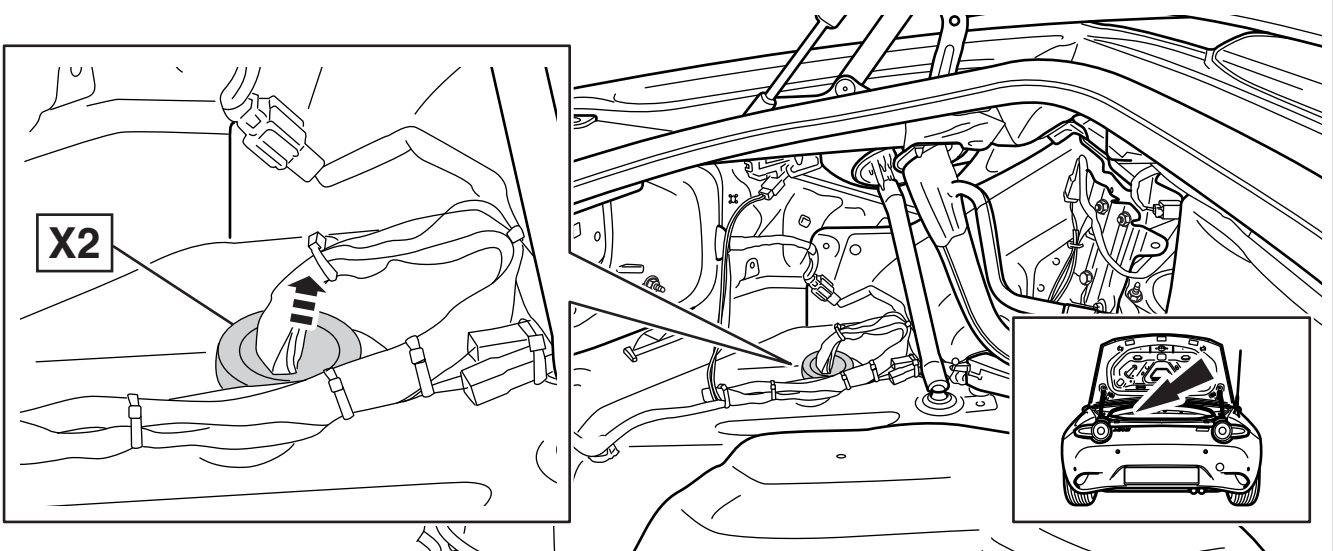

9

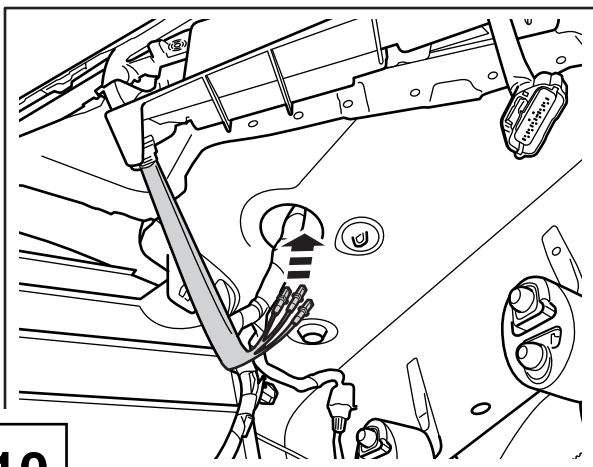

10

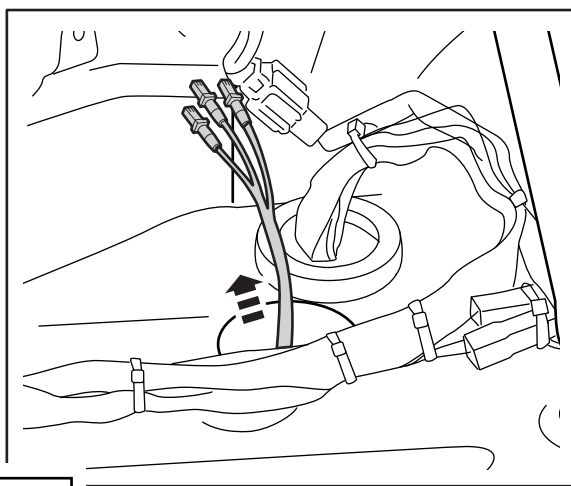
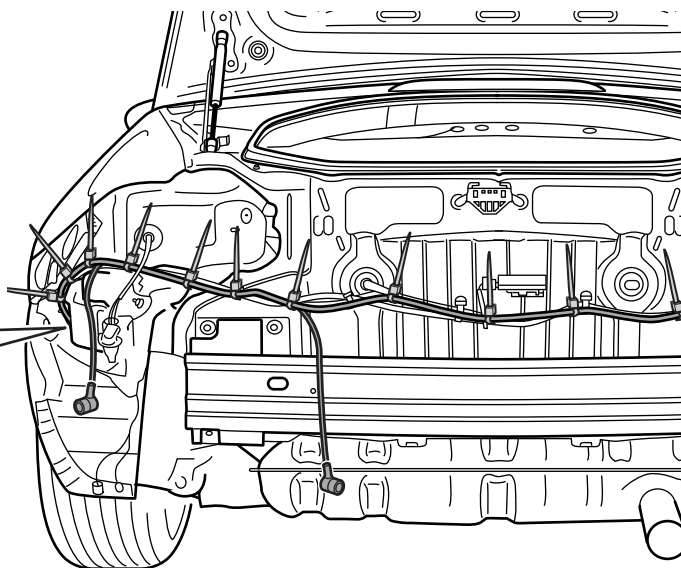

11

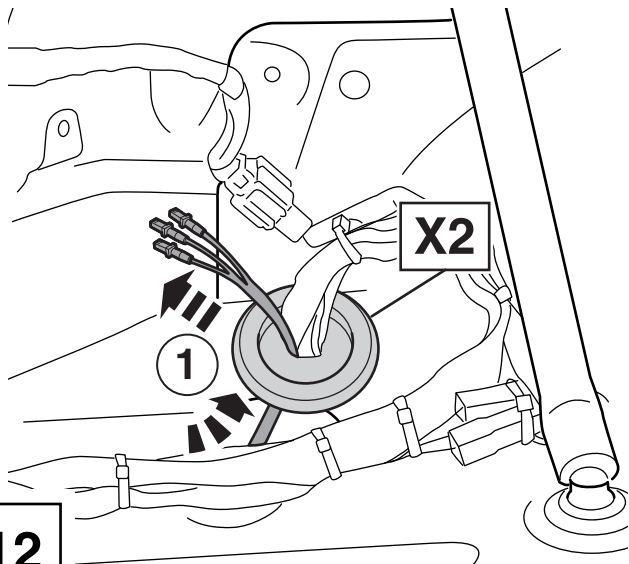
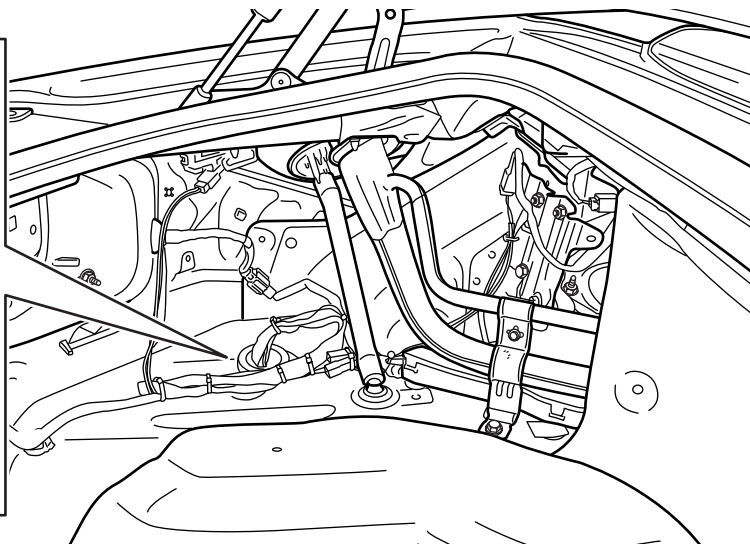

12

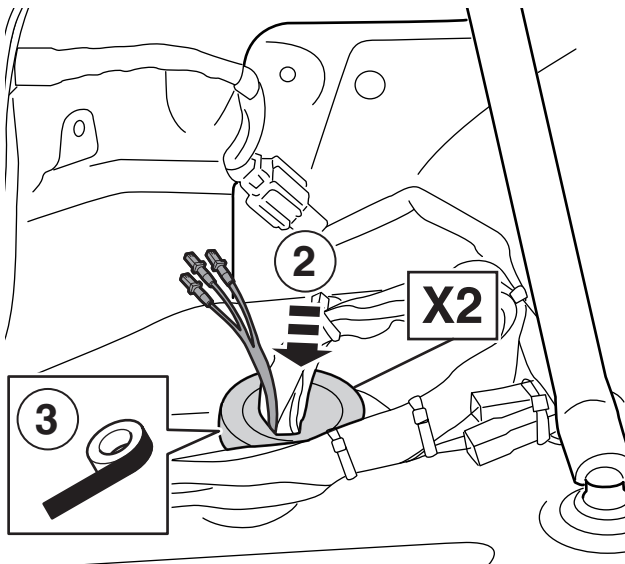

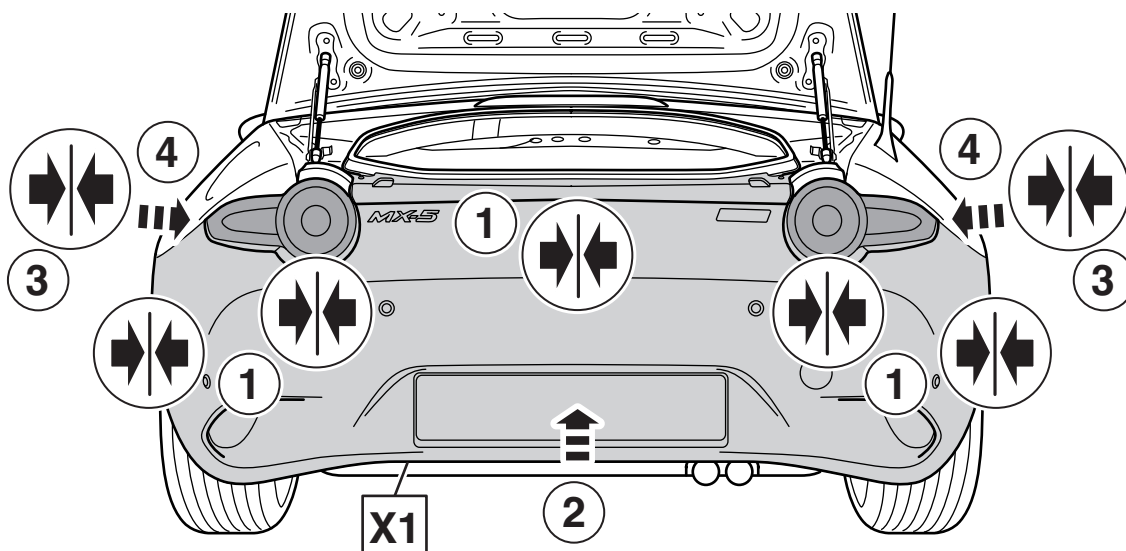

13

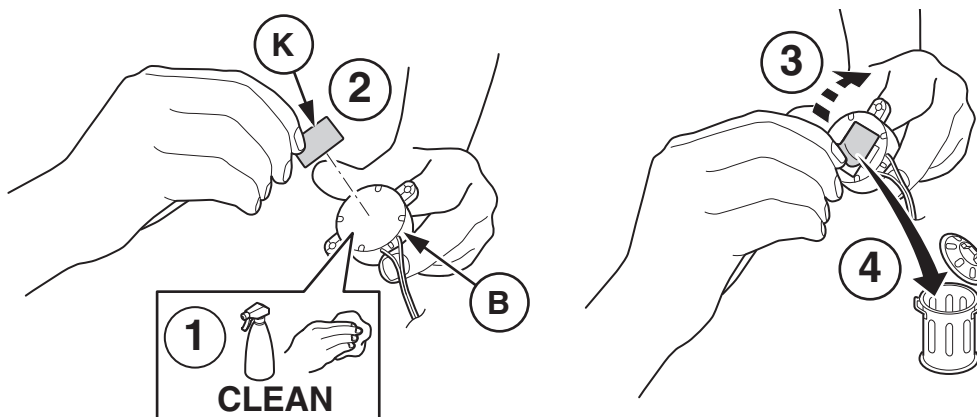

14

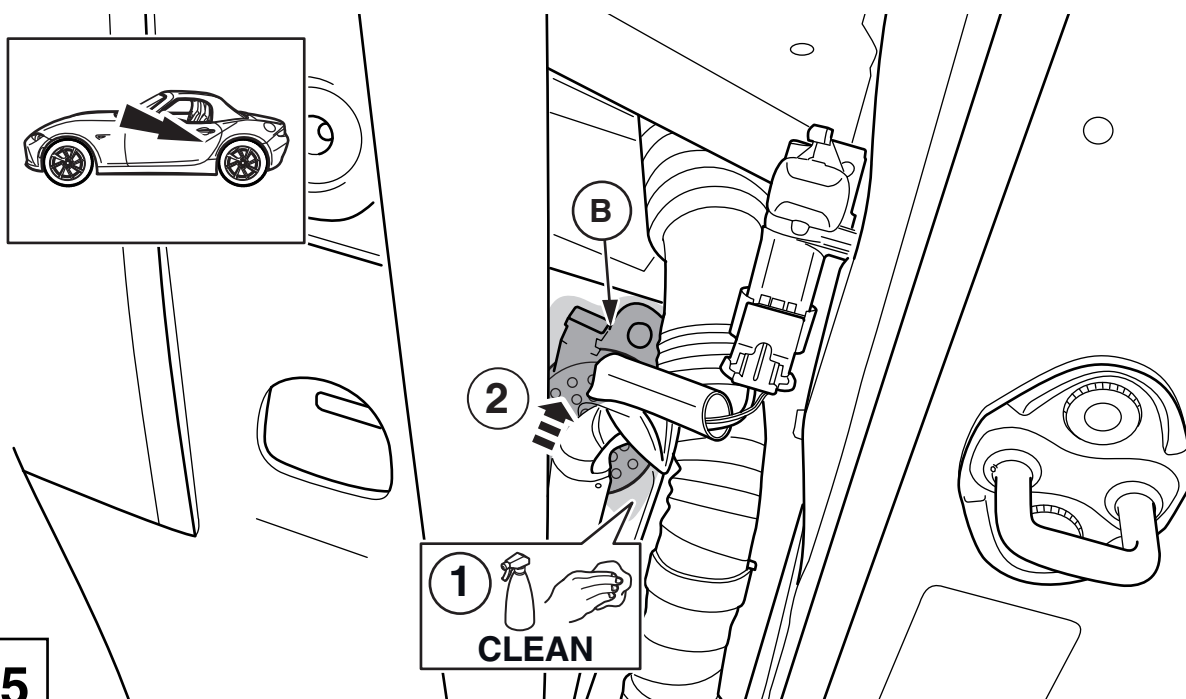

15

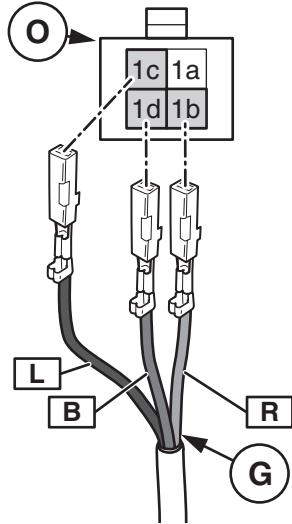
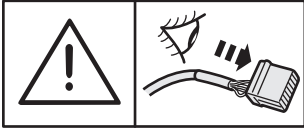

16

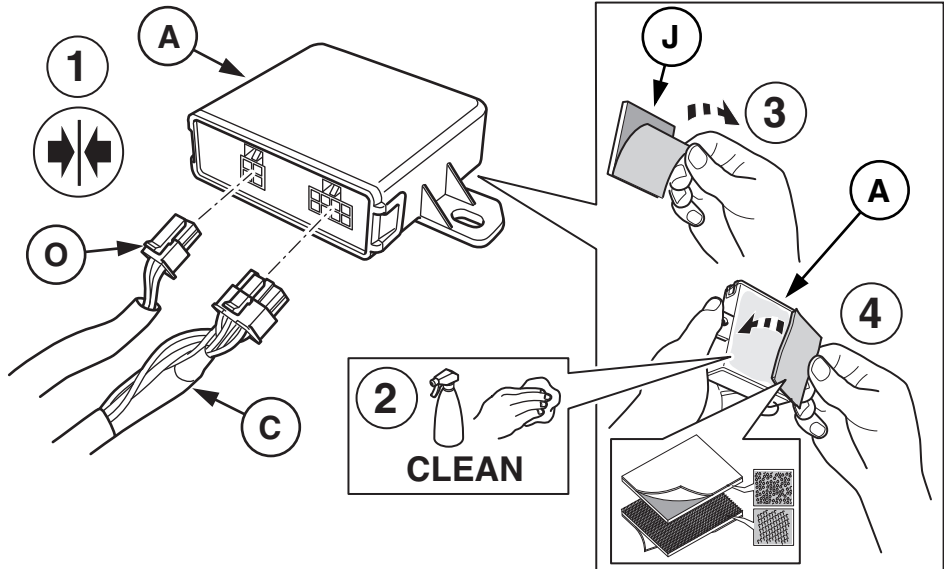

17

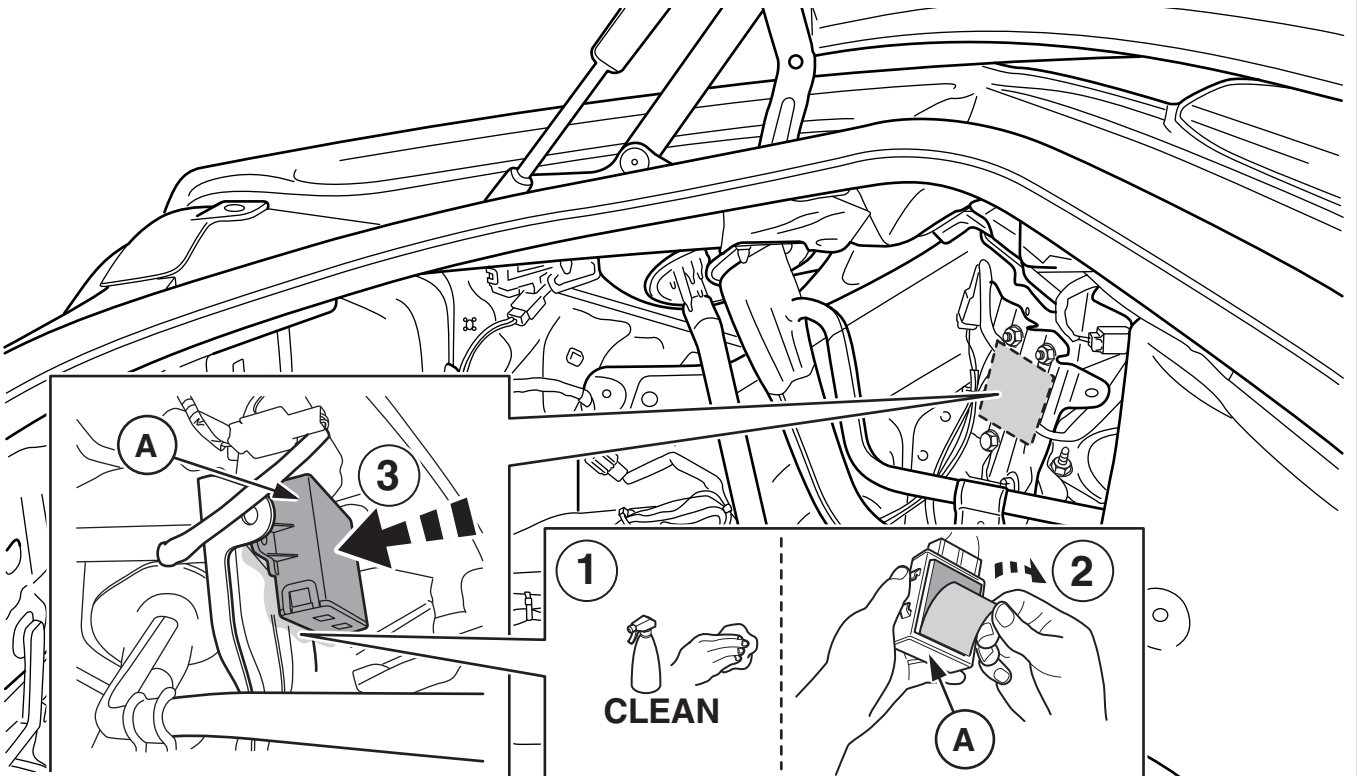

18

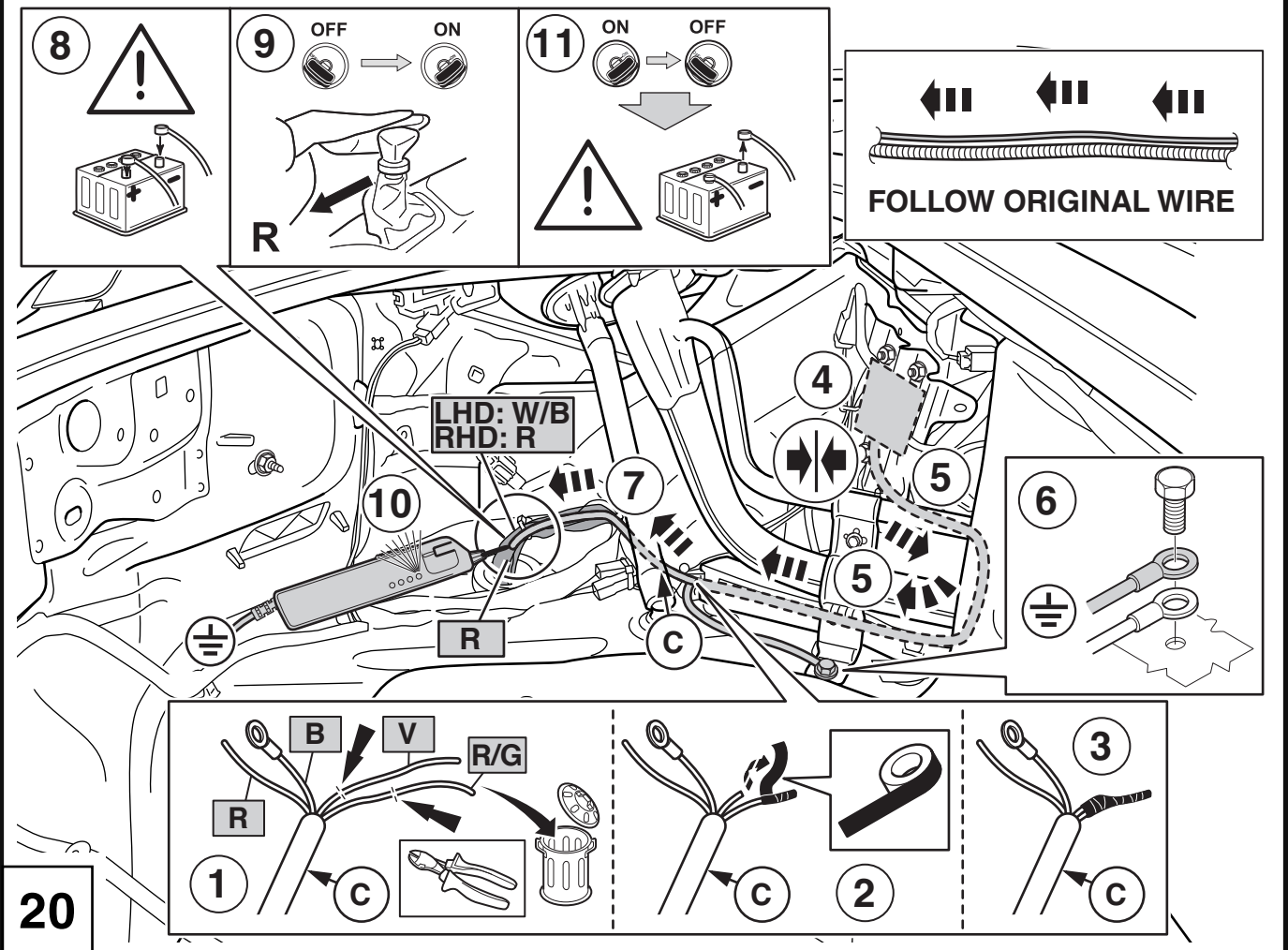
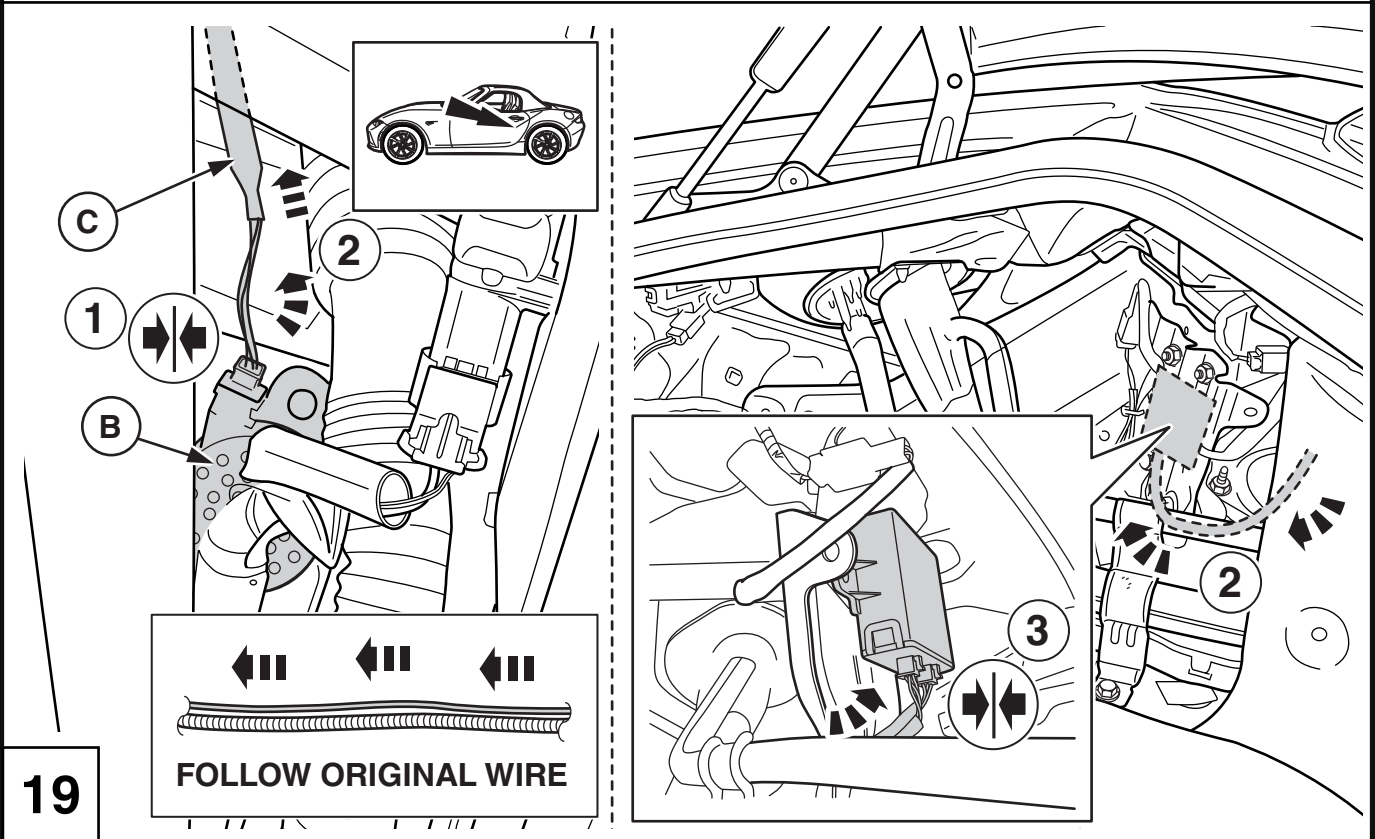

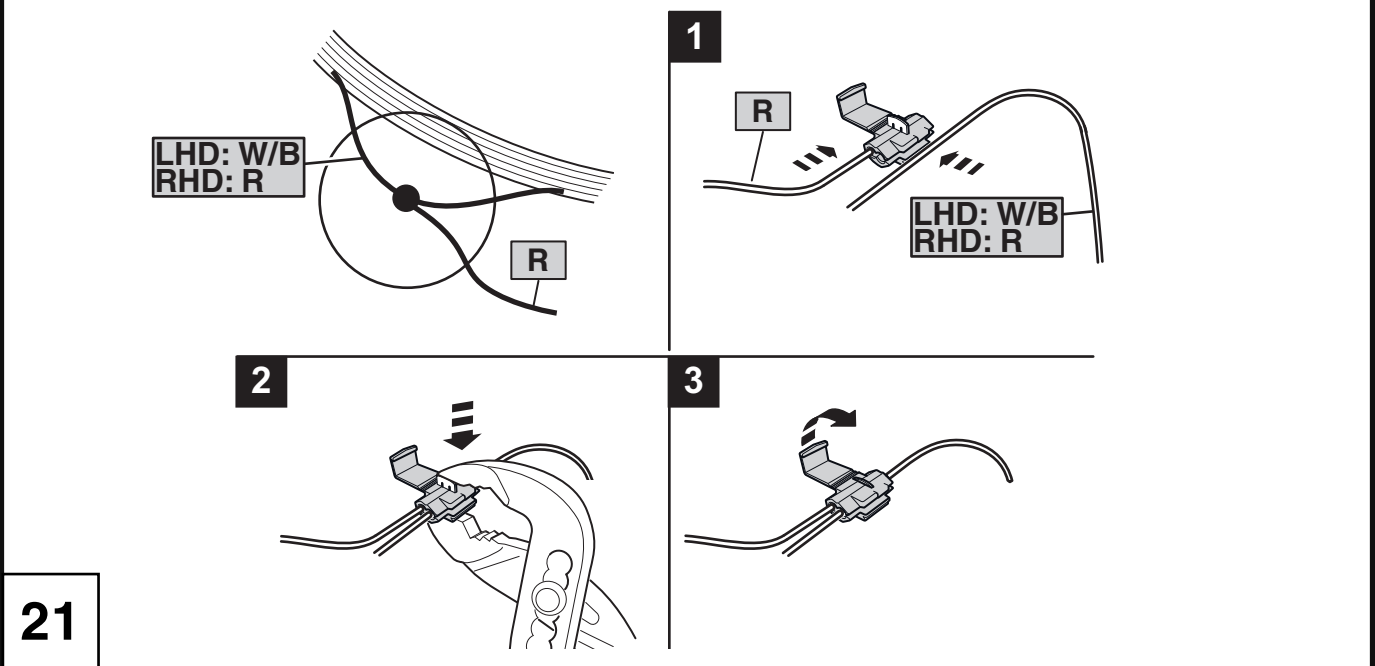

21

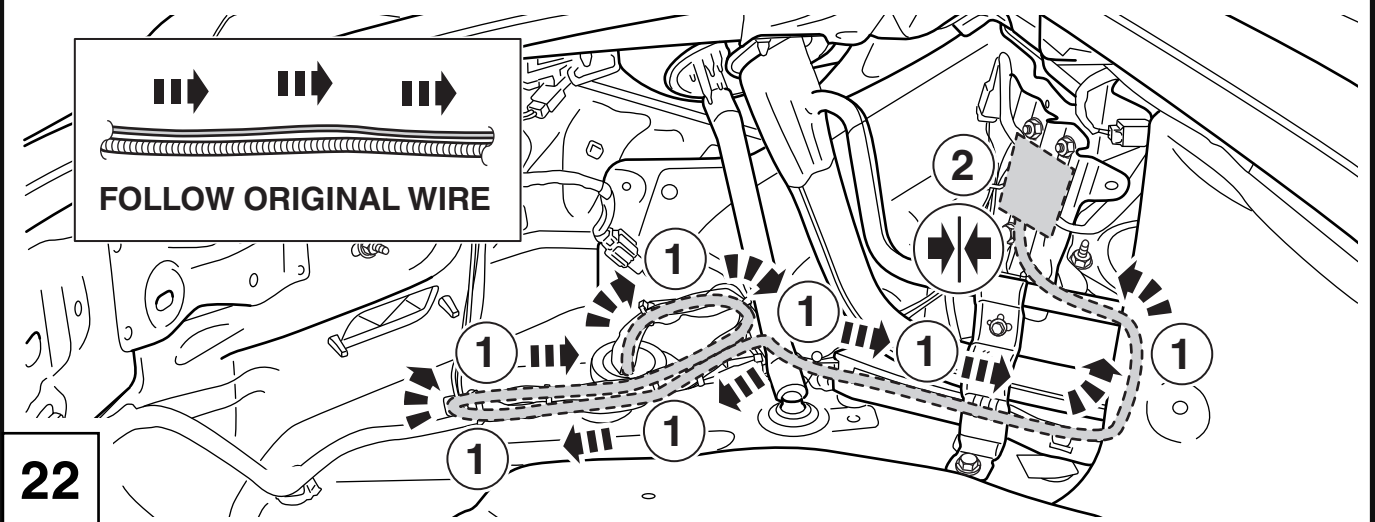

22

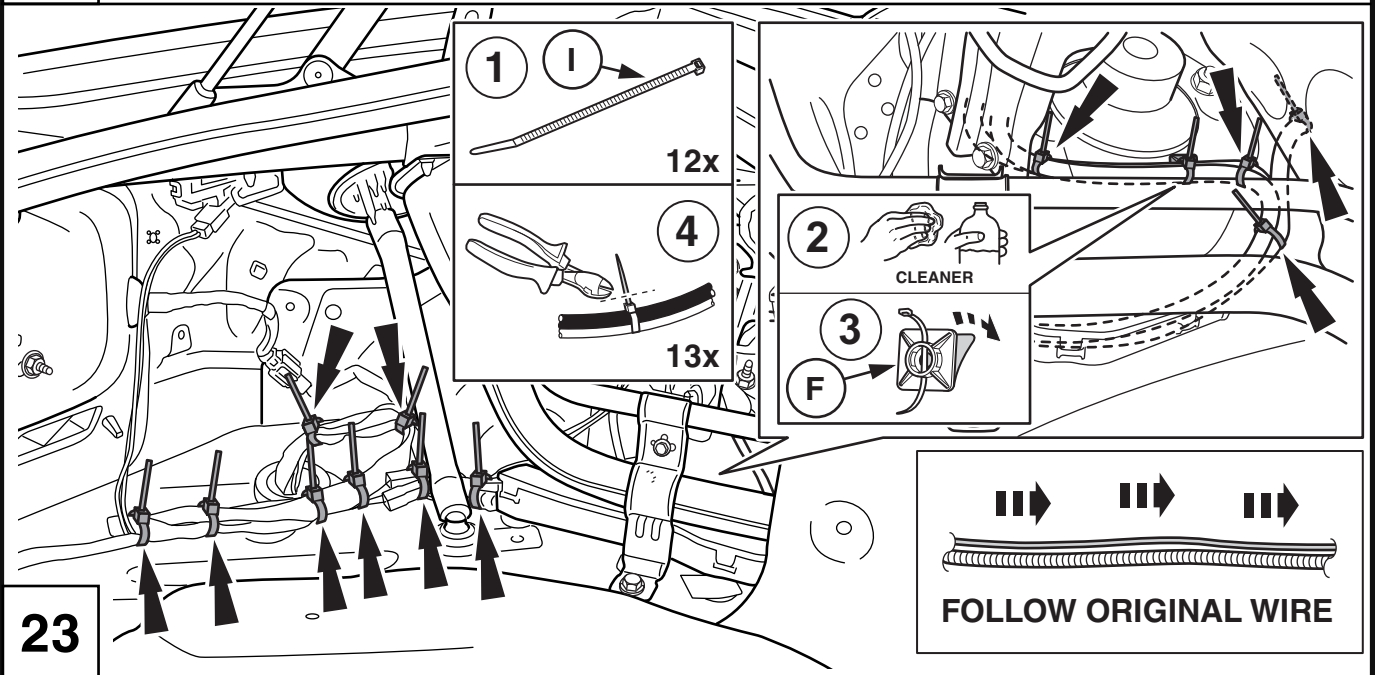

23

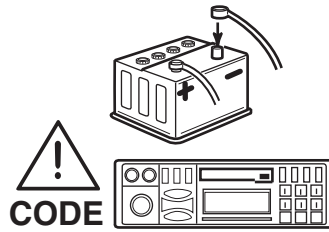

24

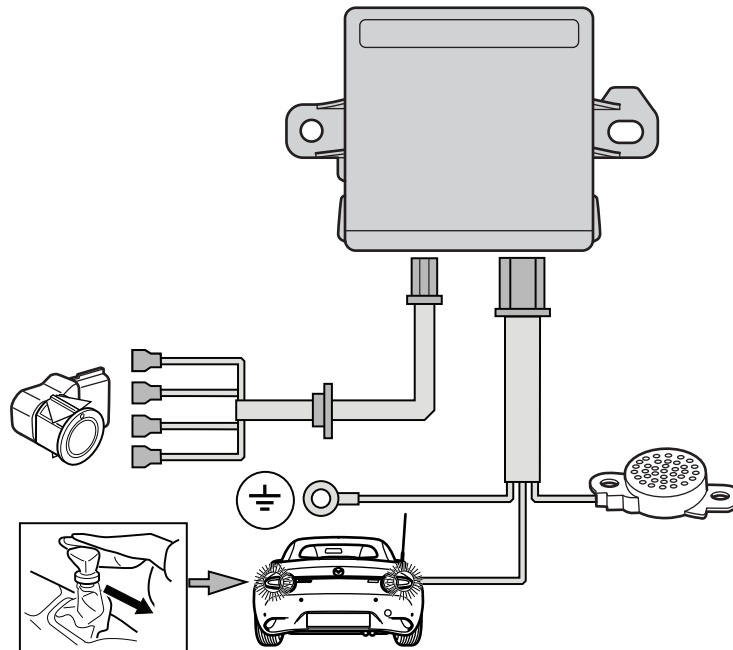

25

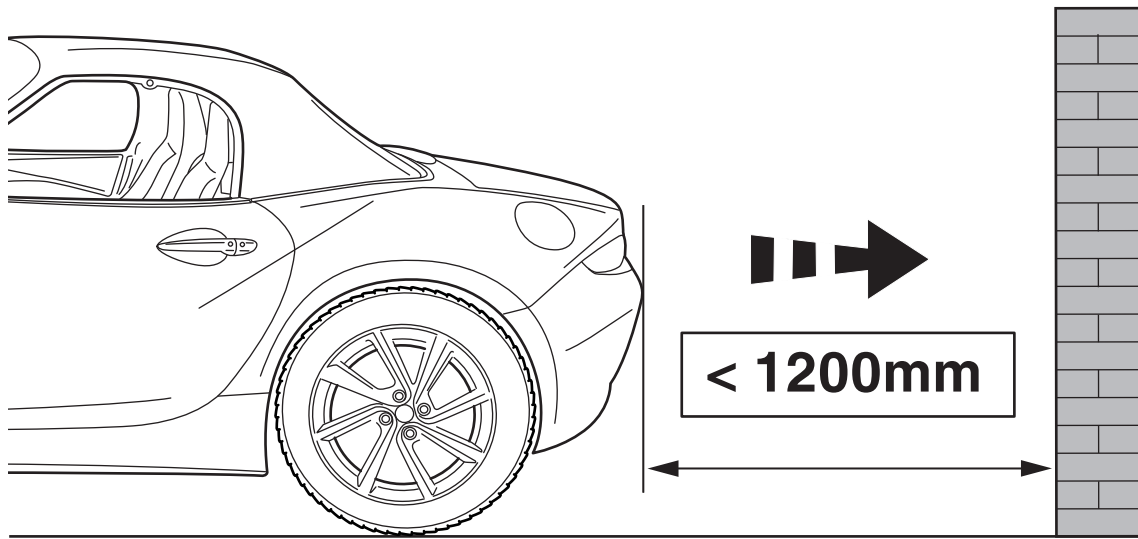
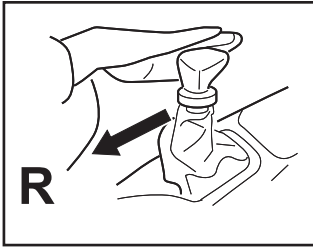

26

System functionality

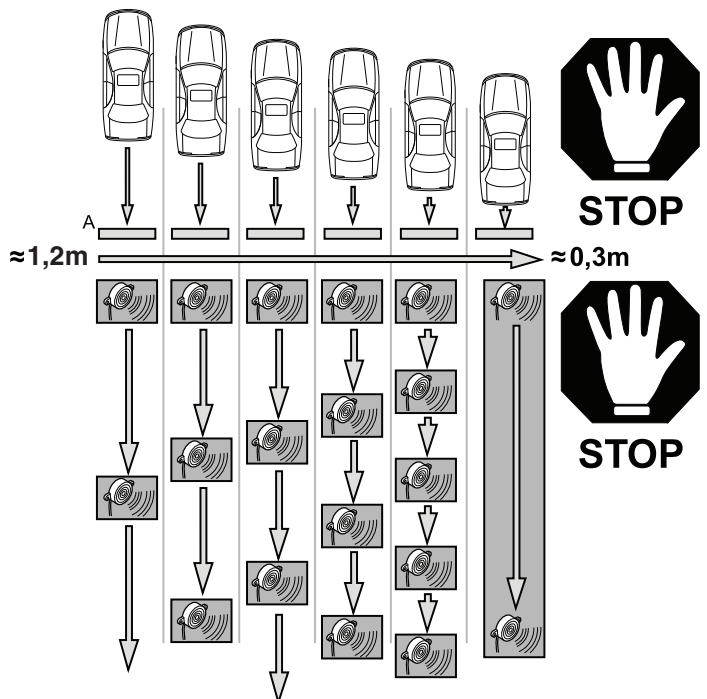
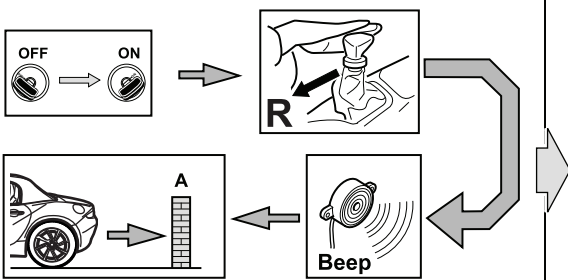

27

memo

06DE4086C