



MAZDA

- GB** REAR BUMPER FOIL
Installation Instruction
- D** SCHUTZFOLIE HECKSTOSSSTANGE
Einbauanleitung
- E** PROTECCIÓN DEL PARACHOQUES TRASERO
Instrucciones de montaje
- F** PROTECTION PARE-CHOCS ARRIERE
Instructions de montage
- I** PROTEZIONE PARAURTI POSTERIORE
Istruzioni di montaggio
- P** PROTECTOR DO PÁRA-CHOQUES TRASEIRO
Instruções de montagem
- NL** BESCHERMING ACHTERBUMPER
Inbouw-instructie
- DK** BESKYTTELSE BAGESTE KOFANGER
Monteringsvejledning
- N** BESKYTTELSE FOR STØTFANGER BAK
Monteringsvejledning

- S** SKYDD BAKRE STÖTFÄNGARE
Monteringsanvisning
- FIN** TAKAPUSKURIN SUOJAUS
Asennusohje
- CZ** OZDOBNÁ FÓLIE NA ZADNÍ NÁRAZNÍK
Návod k montáži
- H** HÁTSÓ LÖKÉSGÁTLO VÉDELEM
Beszerelési utasítás
- PL** NAKŁADKA OCHRONNA NA TYLNY ZDERZAK
Instrukcja zabudowy
- GR** ΠΡΟΦΥΛΑΚΤΗΡΑΣ ΟΠΙΣΘΕΝ
Οδηγίες τοποθέτησης
- RUS** ЗАЩИТА БАМПЕРА
инструкция по установке
- SVK** ZADNÁ NÁRAZNÍKOVÁ FÓLIA
Návod na inštaláciu



MAZDA 2 HYBRID | ZV

Part Number: ZR74-V4-080

Date: 06-12-2021

© Copyright MAZDA

Sheet 1 of 10

Expert Fitment Required
Montage durch Fachwerkstatt erforderlich
Montaje sólo por el concesionario
Montage par spécialiste nécessaire
E' necessario in officina specializzata
Especialista em montagem requerido
Montage door vakman nodig
Montage ved professionelt værksted påkrævet
Nødvendig med montering fra fagvevkersted
Verkstadsmontage erfordras
Asennus tarpeen merkkikorjaamossa
Montáž ve specializované dílně nutná
A szereléshez szakmúhely kell
Konieczny montaż przez warsztat specjalistyczny
Να τοποθεί απο συνεργείο
Необходима установка специалистами
Vyžaduje sa odborné vybavenie

Revision Record

| Rev. No. | Date | Page | Step | Remarks |
|----------|------|------|------|---------|
| | | | | |
| | | | | |
| | | | | |
| | | | | |
| | | | | |
| | | | | |

KIT CONTENT

ZR74-V4-080

A



1x

INFO

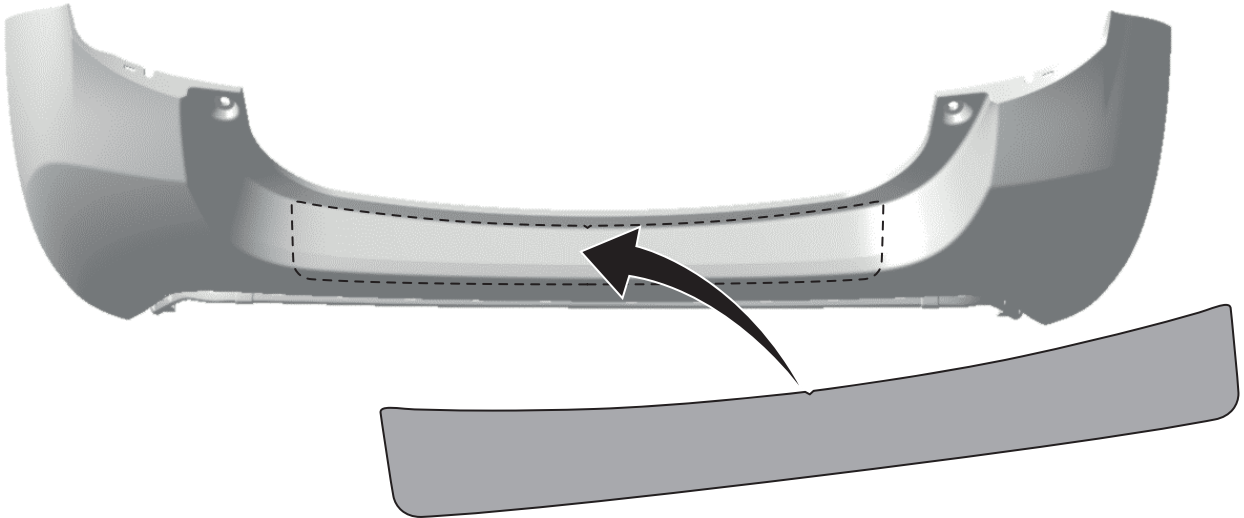

4100-77-005

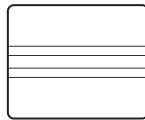

SEPARATE PURCHASE

TOOLS & CONSUMABLES & PPE

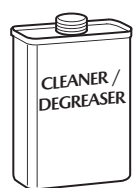
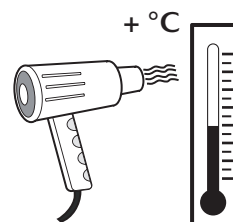
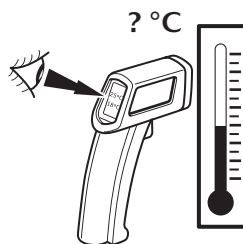
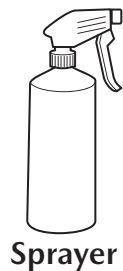

INFO



Material Safety Data Sheet

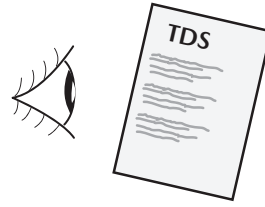

Technical Data Sheet

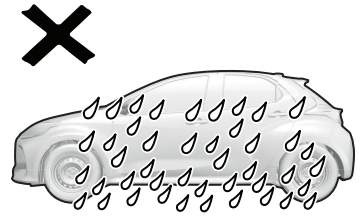
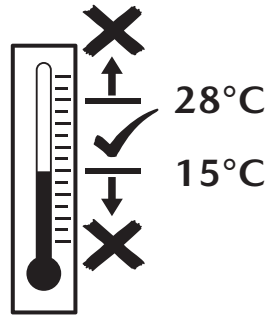
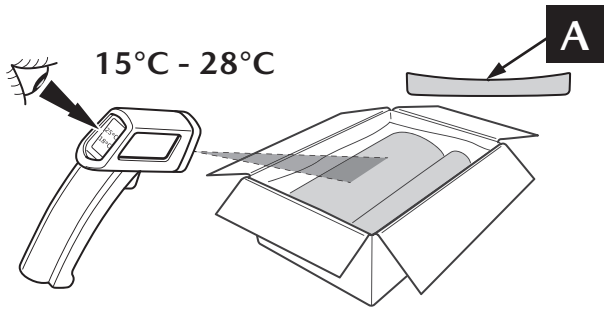
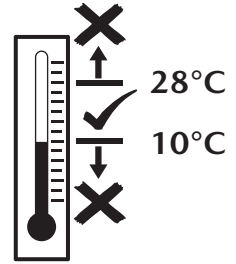
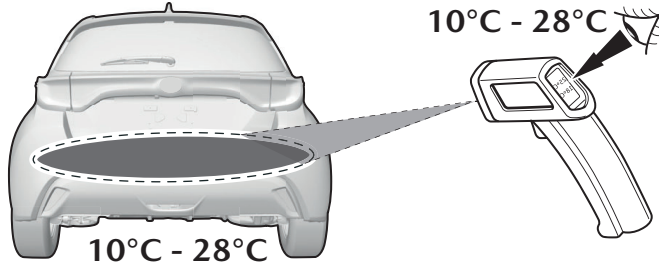

INSTALLATION INSTRUCTIONS



1

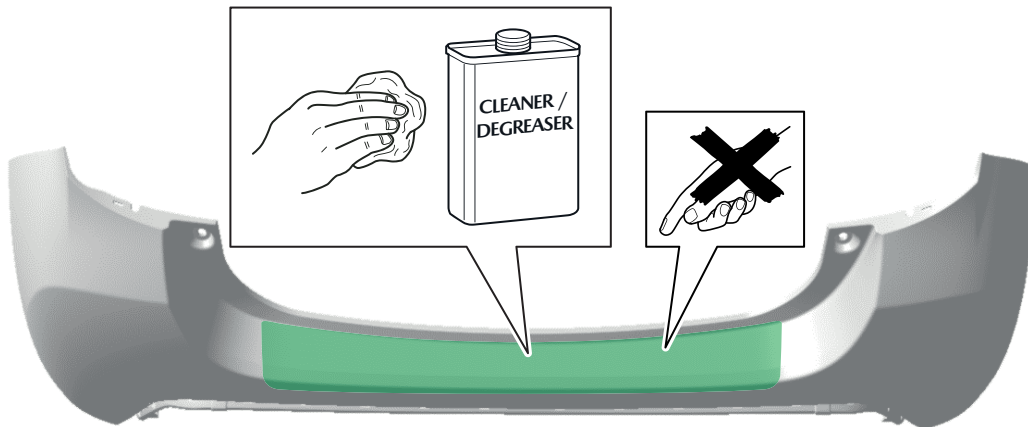

2

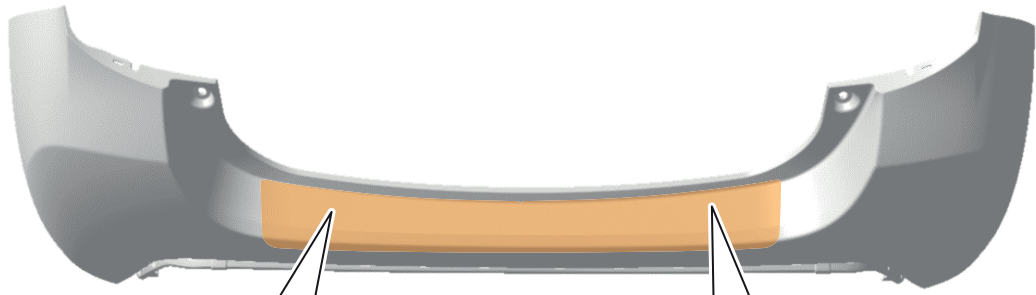

| | | |
|----------|---|---------------------------|
| <p>1</p> | <p>< 10°C → 2</p> <p>10°C - 28°C → 4</p> | <p>2</p> |
| <p>3</p> | <p>10°C - 28°C → 4</p> | <p>INFO</p> <p>3 → 12</p> |

3

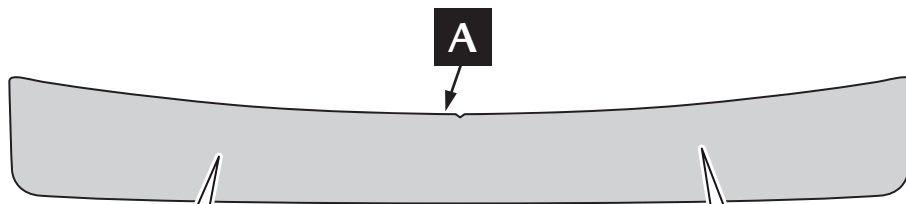

| | | |
|----------|--|---------------------------|
| <p>1</p> | <p>A</p> <p>< 15°C → 2</p> <p>15°C - 28°C → 5</p> | <p>2</p> |
| <p>3</p> | <p>15°C - 28°C → 5</p> | <p>INFO</p> <p>4 → 12</p> |

4

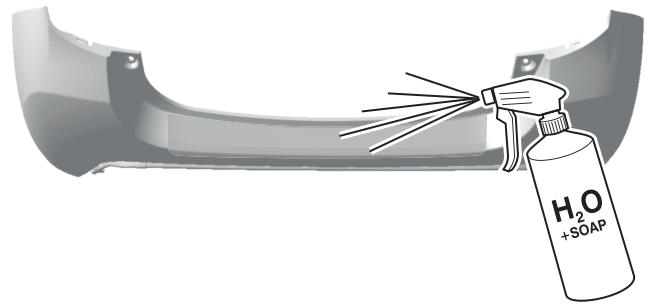
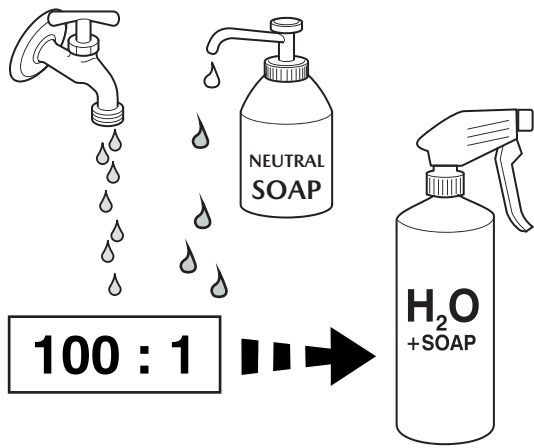

5

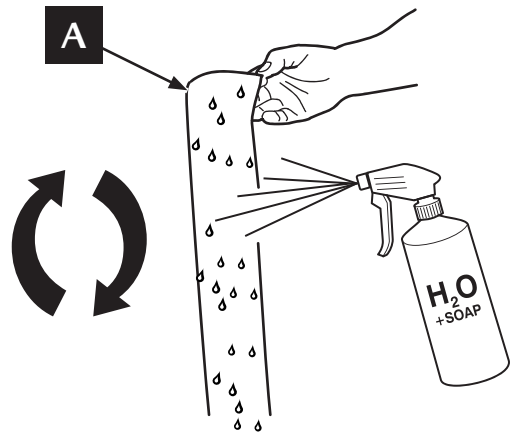
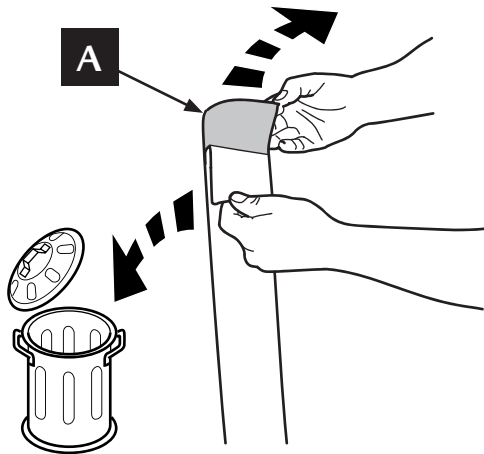

6

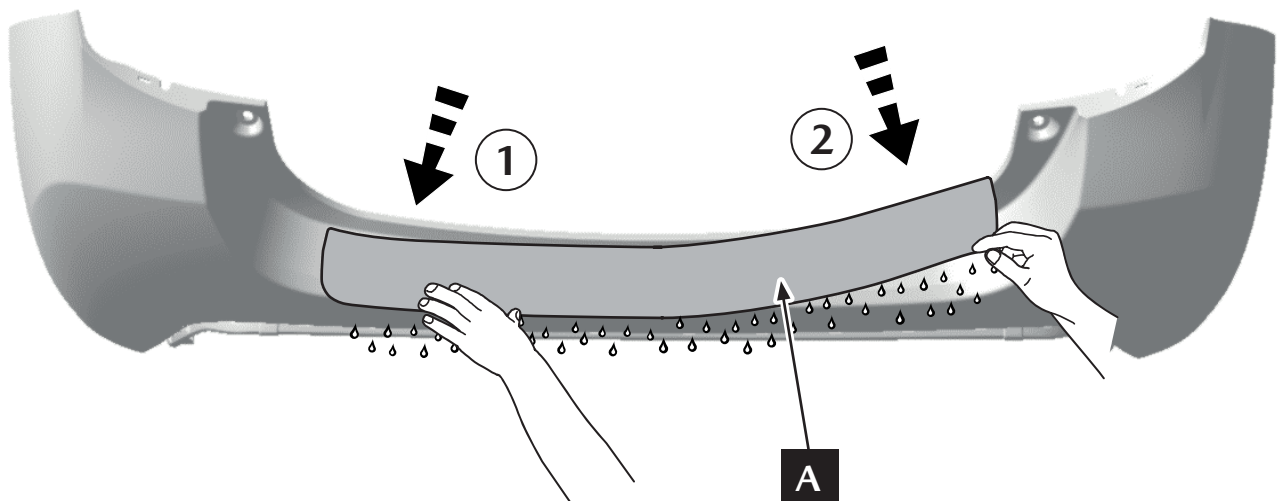

7

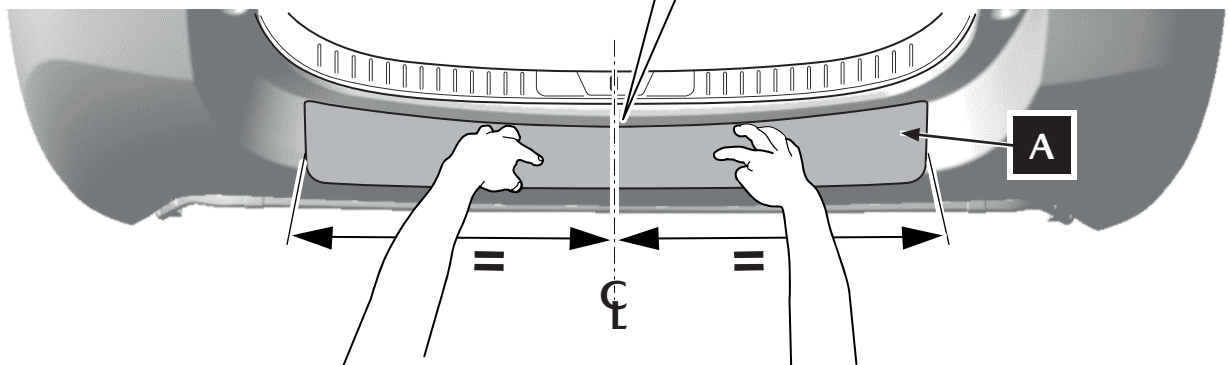
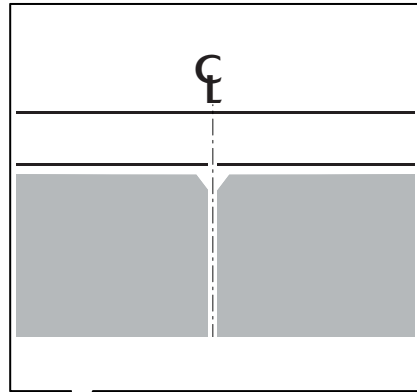
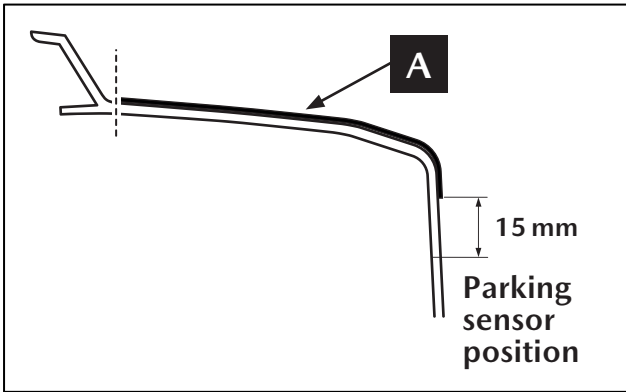

8

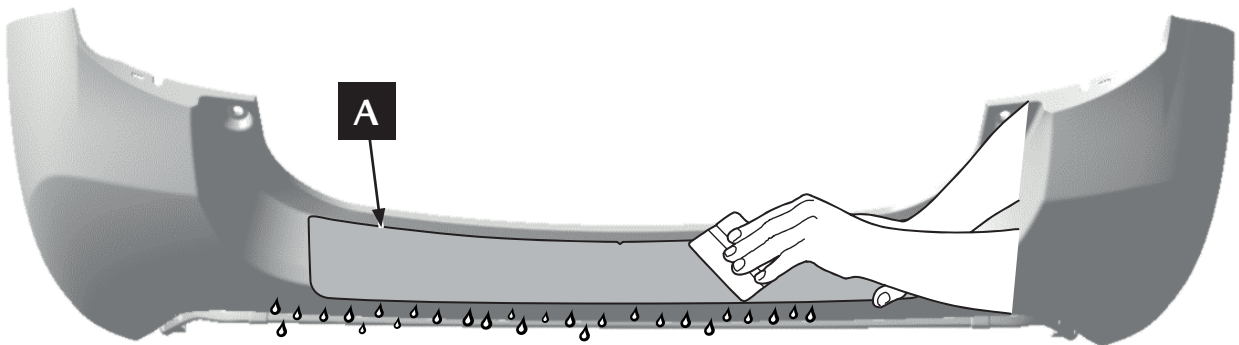

9

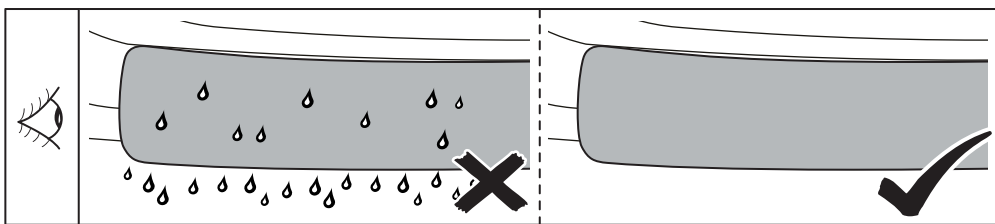
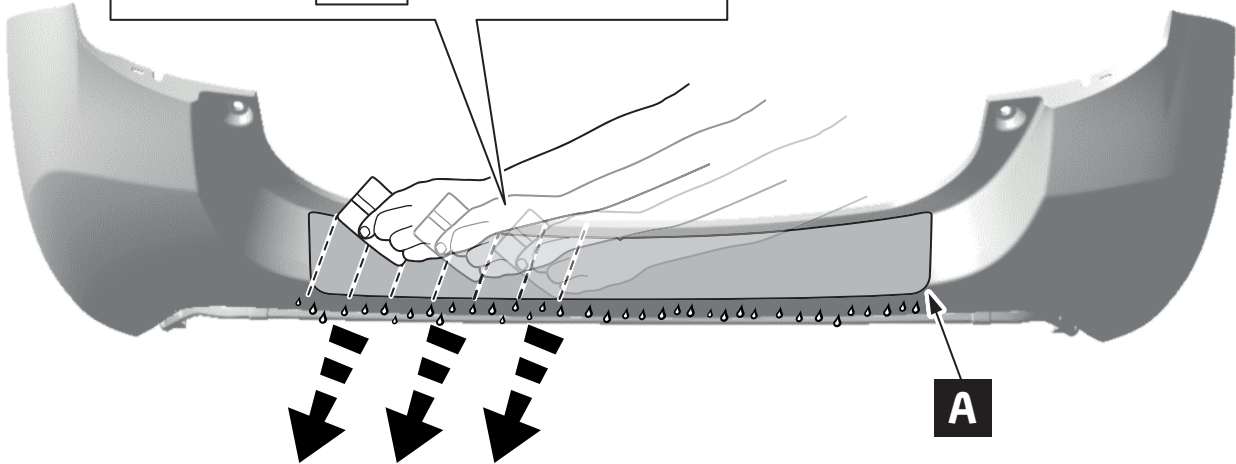
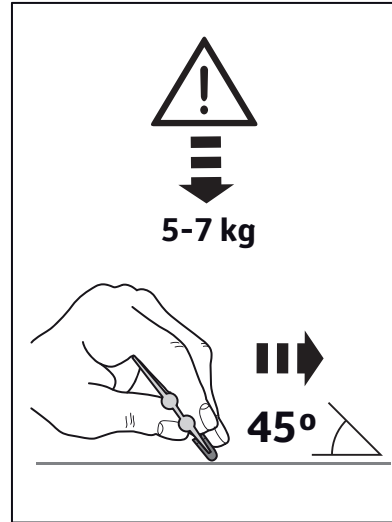
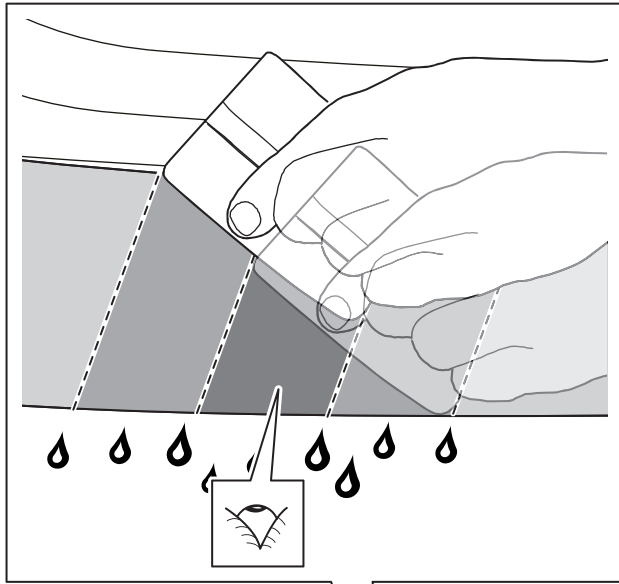

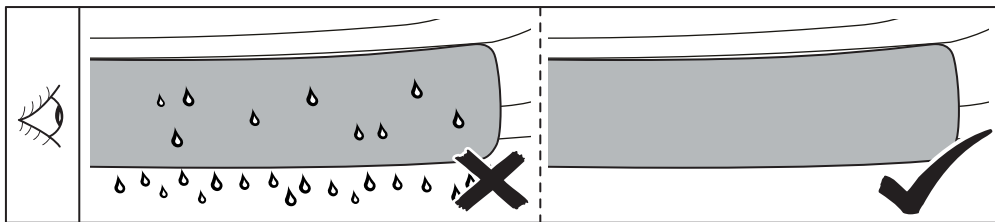
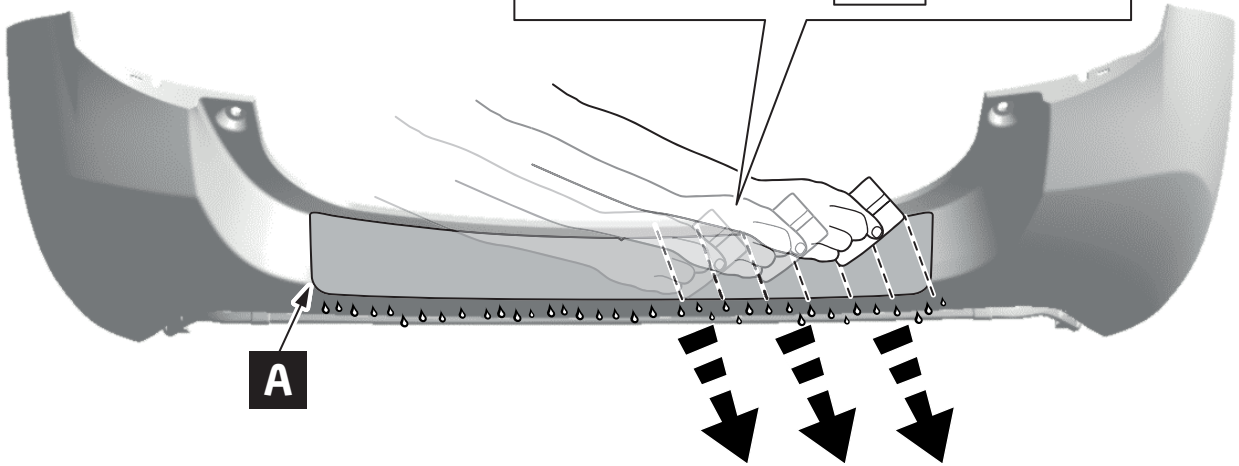
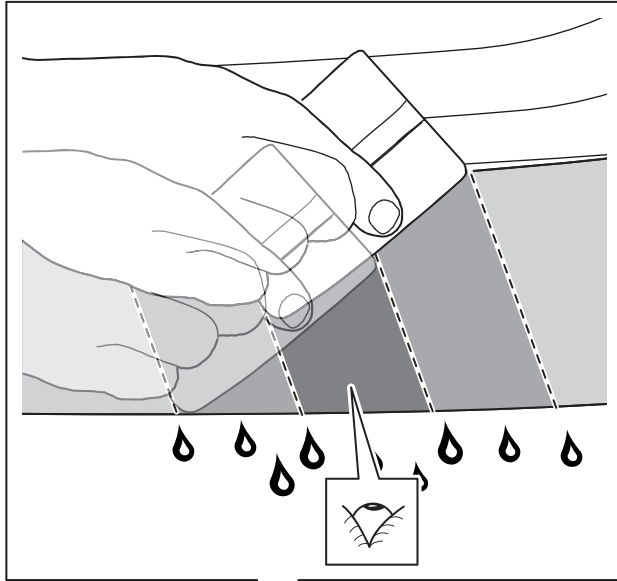
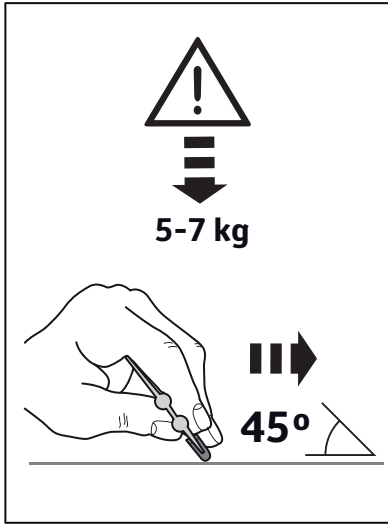

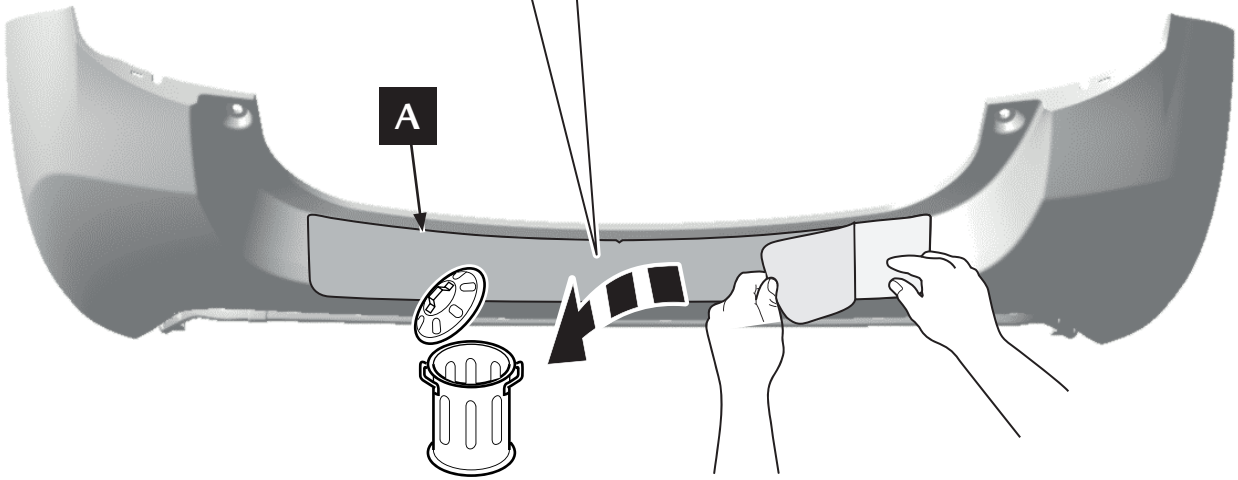
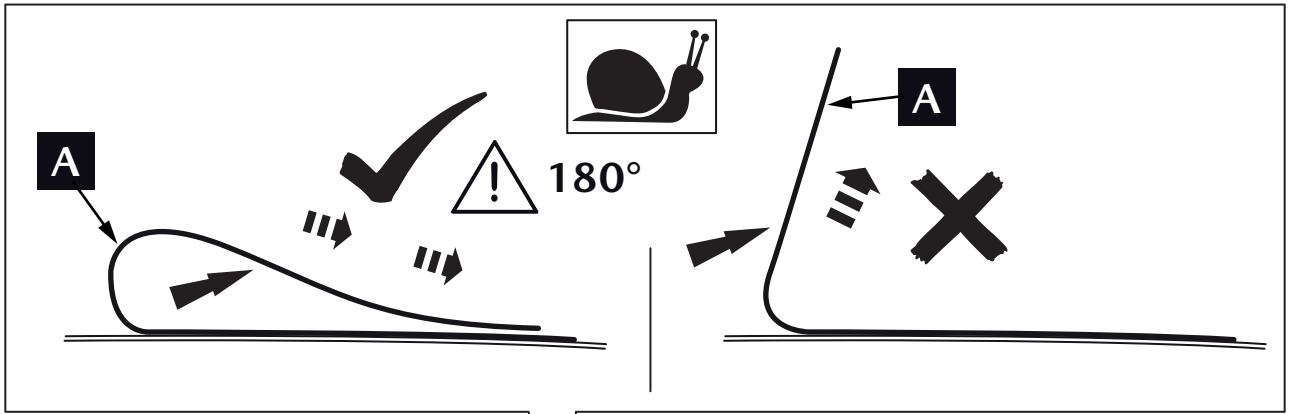

12

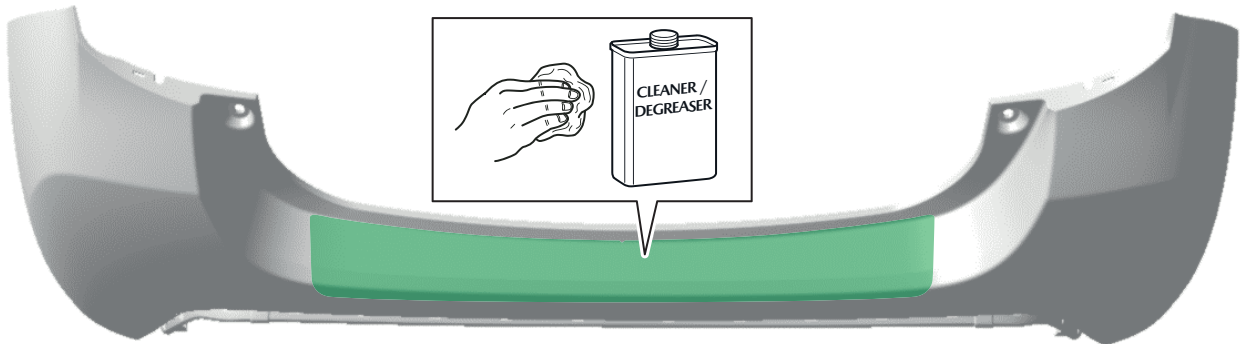

13

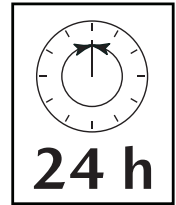
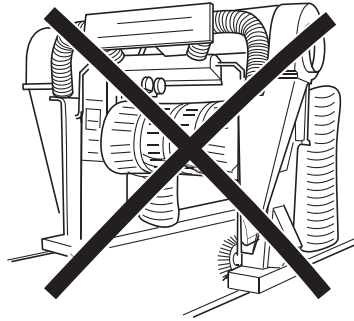
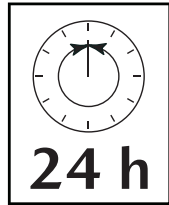
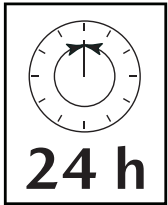

> 1 meter

